

MERIT BADGE SERIES



# FISHING





## How to Use This Pamphlet

The secret to successfully earning a merit badge is for you to use both the pamphlet and the suggestions of your counselor.

Your counselor can be as important to you as a coach is to an athlete. Use all of the resources your counselor can make available to you. This may be the best chance you will have to learn about this particular subject. Make it count.

If you or your counselor feels that any information in this pamphlet is incorrect, please let us know. Please state your source of information.

Merit badge pamphlets are reprinted annually and requirements updated regularly. Your suggestions for improvement are welcome.

## Who Pays for This Pamphlet?

This merit badge pamphlet is one in a series of more than 100 covering all kinds of hobby and career subjects. It is made available for you to buy as a service of the national and local councils of Scouting America. The costs of the development, writing, and editing of the merit badge pamphlets are paid for by Scouting America in order to bring you the best book at a reasonable price.

Send comments along with a brief statement about yourself to  
Program Development Department  
Scouting America • 1325 West Walnut Hill Lane • Irving, TX 75038 If you  
prefer, you may send your comments to [merit.badge@scouting.org](mailto:merit.badge@scouting.org)

SCOUTING AMERICA  
MERIT BADGE SERIES

# FISHING



*"Enhancing our youths' competitive edge through merit badges"*

Scouting  America.

# Requirements

Scouts should go to [scouting.org/merit-badges/fishing](https://scouting.org/merit-badges/fishing) or check Scoutbook for the latest requirements.



Scan this QR code for the latest Fishing requirements.

35899  
ISBN 978-0-8395-0146-6  
©2026 Scouting America  
2026 Printing



Earning the Scouting America Complete Angler Award could help you expand your fishing knowledge and experiences. To become eligible for the award, start by earning these three merit badges: Fishing, Fly-Fishing, and Fish and Wildlife Management. Then complete one or more of the following projects:



- Teach a Fishing or Fly-Fishing merit badge skill to your unit as part of a program activity.
- Help instruct Cub Scouts on fishing skills or fishery management as part of a Cub Scout meeting or outing.
- Participate in a local fishing derby or tournament, either a Scouting or community event.
- Complete a conservation project that will benefit a local fishery.

With the Complete Angler Award, you can become a mentor for younger Scouts, sharing your knowledge and helping others to enjoy a positive fishing experience. For more information, visit [scouting.org/outdoor-programs/fishing](https://scouting.org/outdoor-programs/fishing)

Scouts should obey all local fishing regulations and property laws.



## Contents

Introduction . . . . .	6
Safety Practices . . . . .	9
The Nature of Fish . . . . .	17
Freshwater Fish . . . . .	31
Saltwater Fish . . . . .	43
Balanced Tackle . . . . .	47
Fishing Gear and Craft . . . . .	70
Cleaning, Filleting, and Cooking Fish . . . . .	76
Protecting Gamefish Resources . . . . .	81
Glossary . . . . .	92
Fishing Resources . . . . .	94

# Introduction

This pamphlet will tell you a lot about fish and how to catch them. You might catch them for fun and “sport,” or to eat. Fishing can become a lifetime pursuit, like golf or tennis. Many kinds of fish are described here, along with many ways to catch them—there are always new challenges in fishing, and always more to learn. This is one merit badge you are sure to enjoy earning from the very start.

As for beginnings, fishing has a long and interesting history. As soon as early humans discovered that there were fish in the waters and that the fish were good to eat, they began to devise methods for catching those fish. They quickly found that it was easier to spear fish than to grab them with their hands. Later, they discovered that they could catch even more fish by using woven nets.

After observing fish while they were feeding, these early peoples began catching fish by putting a sliver of bone inside a bait with a thong fastened to the middle of the bone. When the fish grabbed the bait and swallowed it, the piece of bone caught crosswise inside the fish, allowing it to be pulled in. This birth of angling, long before humans began recording history, led to the invention of fishhooks, made first of bone and later of metal.

The initial intent of catching fish was to get food. However, even early humans found that trying to outwit a fish with a line and bait was an intriguing pursuit with considerable excitement when a big fish latched on to the hook. Eventually, fishing evolved into a sport, and anglers devised finer, lighter **tackle**, making it more challenging to hook a fish and giving the fish an opportunity to beat anglers at their own game. Thus was born the sport of fishing, distinct from commercial fishing or fishing for food.



---

Words shown in **bold print** appear in the glossary near the back of this pamphlet.

---



## Baden-Powell's Love of Fishing

Robert S.S. Baden-Powell, the founder of the Scouting movement, claimed fishing as one of his favorite pastimes. As the Chief Scout of the growing Scouting movement during the early 20th century, Lord Baden-Powell traveled the world to attend jamborees and provide leadership and inspiration. Everywhere he went, his fishing rods, reels, and fishing kit went with him. Baden-Powell's biographer E.E. Reynolds wrote, "When he needed to get right away from everything and everybody, he would go off for a few days' fishing."

In *Scouting for Boys*, Baden-Powell offers this advice to the young fisherman: "Every Scout ought to be able to fish in order to get food for himself. A tenderfoot [beginner] who starved on the bank of a river full of fish would look very silly, yet it might happen to one who had never learned to catch fish."

It's no surprise that fishing remains a favorite pastime on Scout outings.

---

In his book *Lessons From the Varsity of Life*, Baden-Powell declares, "Trout fishing is the best rest-cure in the world."

---



---

---

# Safety Practices

When fishing, you might add to the Scout motto, “Be Prepared,” the advice “Be Careful.”

## Trip Itinerary

Always fish with at least one other person and always tell your parents or guardian where you are going and when you expect to return. If fishing in a remote area, leave your trip plan with a resort owner or dock operator. If nothing else, leave your written itinerary under the windshield wiper of your car. If you run into trouble, trained searchers will know where to look for you.

## Wading

Wading can be treacherous, particularly in the spring when water is high or late in the fall when water is cold. Use a wading belt, as it can reduce the flow of water into your chest waders if you fall in. It is best to start wading in shallow water before venturing farther out. This will help you gauge water current and depth. It will also help if you wade diagonally rather than launching into the current straight on.

Rock-bottom streams often are slippery. Experienced anglers take small steps and wade slowly, moving one foot ahead and feeling the bottom while supporting the body weight on the other foot. Steel cleats or felt boot soles, where permitted, sometimes help, as will walking around slippery rocks rather than over them whenever possible.

A wading staff, tied to a wading belt with a thong, can be a handy aid in fast water. If you lose your footing, you may have to float downstream. Don't panic; you won't sink even with your waders full of water. Float feet-first to fend off any rocks, and work your way toward shallow and calmer water where you can regain your footing.

Water level below dams can change rapidly when excess water is released. Be aware of a siren signaling a water release, or if you observe water change, retreat to safety.

---

If the water is too high or too fast, go fishing elsewhere. Try a lake or a pond.

---

Avoid alcohol at the waterfront. Despite the fact that it is illegal for anyone under 21 to drink alcoholic beverages, alcohol is a factor in half of all drownings among teenagers and adults. The death rate is especially high among young men ages 15 to 24.

## Boating

Weather is a chief concern when on the water. It pays to check the forecast before venturing offshore and to keep an eye out for threatening clouds, the signal to get back to shore—fast. A responsible angler should learn the water and carry an accurate depth map or chart, compass, whistle, mirror, and other safety gear.

A serviceable boat repair kit is essential for emergencies. Check running lights to make sure they operate properly. Learn the boating laws of your state and those of the U.S. Coast Guard. Know before you go!



**Always be aware of the tides changing and of rapidly rising water.**

## Canoe Travel

The canoe is a superb craft for fishing but has special requirements for use. Never stand in a canoe. When fishing in heavy waves or in fast currents, it usually is best for the bow angler to do the casting and for the stern paddler to keep the craft under control. It may be desirable to have an anchor made out of a mesh bag filled with rocks. In streams, anglers sometimes use a push pole, fitted with pointed steel “shoes” on the bottom. The pole allows the craft to be moved upstream easily and also can be used to snub up against rocks going downstream to hold the canoe in place when fishing a particular spot.

Sometimes it is advisable not to land an especially big fish in the canoe. Instead, take it to the shore and beach it. Once the bow is eased up on a sand or gravel bar, you can get out in the shallow water where the fish gradually can be brought in close enough to net. Be careful when landing any fish, because spiny fins, sharp teeth, and sharp gill covers (such those on the walleye) can inflict nasty cuts that may get infected. Any such cut should be cleaned and covered with an adhesive strip.

Wise canoe anglers keep all extra gear lashed to the thwarts in case of a spill. Inflatable camera bags and floatable containers for tackle may help prevent an expensive loss. A good flashlight or lantern will help you find directions in the dark and is essential for signaling oncoming motorboats.

In any watercraft, either canoe or boat, you should always wear a U.S. Coast Guard–approved personal flotation device (PFD). Newer PFDs are less bulky than they used to be and do not interfere with casting. There are fishing vests with inflatable pouches that do not look like life jackets but serve the purpose.

---

It's always a good idea to carry an extra paddle in case one breaks or is lost.

---

## Near-Drowning

Drowning is the third leading cause of accidental death in the United States. You can prevent a near-drowning situation by following a few important safety practices.

Should your boat capsize, stay with the boat. It will be easier for rescuers to spot something the size of a boat than a person treading water. In addition, you might be able to climb onto the boat to await rescue.

Whenever you are afloat or in the water, remember to practice the buddy system and follow Scouting America's Safety Afloat plan. Doing so will make your outdoor adventure safer and more fun.

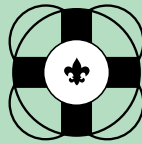

Be sure you follow Scouting America's Safe Swim Defense plan on all Scout outings that include water activities (your adult leader can review this with you). See the *Swimming* merit badge pamphlet for more information about safe swimming skills. Information on how to respond to a near-drowning victim can be found in the *First Aid* and *Lifesaving* merit badge pamphlets.

Monitor a hypothermia victim closely for any change in condition. Do not rewarm the person too quickly (for instance, by immersing the person in warm water); doing so can be dangerous to the heart.

## First Aid and Fishing

For more detailed information on first aid, see the *First Aid* merit badge pamphlet and the *Scouts BSA Handbook for Boys* or *Scouts BSA Handbook for Girls*.

## Hypothermia

Hypothermia is the lowered internal body temperature that occurs when the body loses heat faster than it can produce it. Water or air temperatures lower than 70 degrees Fahrenheit pose hypothermia risks, and rain, moving water, wind, and wet clothing substantially increase the loss of body heat. Any combination of cool weather and damp clothing, wind, exhaustion, or hunger can lead to hypothermia. In fact, most cases of hypothermia occur when the air temperature is well above freezing.

The best way to deal with hypothermia is prevention. Dress appropriately for the weather; always carry rain gear to keep yourself and your clothing dry. Wear a hat and proper footwear, eat plenty of energy-boosting foods, drink an adequate amount of fluids (hypothermia increases the risk of dehydration), and do not push yourself to a dangerous point of fatigue.

## Dehydration

When we lose more water than we take in, we become dehydrated. Symptoms of mild dehydration include increased thirst, dry lips, and dark yellow urine. Symptoms of moderate to severe dehydration include severe thirst, dry mouth with little saliva, dry skin, weakness, dizziness, confusion, nausea, cramping, loss of appetite, decreased sweating (even with exertion), decreased urine production, and dark brown urine. For mild dehydration, drink a quart or two of water or sports drink over two to four hours. Rest for 24 hours and continue drinking fluids. See a physician for moderate to severe dehydration, which requires emergency care.

## Heat Reactions

Protect yourself against heat reactions such as heat exhaustion and heatstroke by staying well-hydrated. Drink plenty of water; don't wait until you are thirsty to drink, or it may be too late.

In hot weather, watch for signs of heat exhaustion (pale, clammy skin; nausea and fatigue; dizziness and fainting; headache, muscle cramps, weakness) and heatstroke (very hot, red skin that can be either dry or damp with sweat; rapid

and quick pulse, noisy breathing; confusion and irritability; unwillingness to accept treatment; unconsciousness). If you or someone in your group shows signs of a heat reaction, get to a cool, shady place. Have the person lie down with the feet, head, and shoulders slightly raised, and remove excess clothing. Cool the victim any way you can (cover the person with cool, wet towels, or sponge the person with cool water; fan the person; place the victim in a stream). Keep a close watch over the victim. If you do not see a rapid recovery, seek medical attention right away.

## Sunburn

Most sunburns are first-degree burns, but prolonged exposure to the sun can cause blistering—a second-degree burn. Sunburn is easy to prevent by applying plenty of sunscreen and clothing with a sun protection factor (SPF) rating of at least 30. Reapply if you are sweating and after you have been in water. A broad-brimmed hat, long-sleeved shirt, and long pants provide even more protection.

If you or a companion gets sunburned, prevent further injury by getting out of the sun and into the shade. If there is no shade, put on a brimmed hat, pants, and a long-sleeved shirt that will afford protection from the sun. Treat painful sunburn with damp cloths. Remedies containing aloe vera might also provide relief.

## Minor Injuries

It is a good rule of thumb to keep a first-aid kit with your fishing gear. Use it to treat minor injuries such as cuts, scrapes, and insect bites. For injuries in which the skin is broken, wash the area with soap and water or clean it with antiseptic to help prevent infection. Severe wounds need immediate medical attention.

The bites or stings of insects, spiders, chiggers, and ticks can be itchy and painful. Some can cause infection or even Lyme disease. Applying calamine lotion may bring relief, but the most important thing to remember is to try not to scratch. Applying an ice pack to these injuries can help reduce swelling.

For a bee or wasp sting, scrape away the stinger with the edge of a knife blade. Do not try to squeeze it out. That will force more venom into the skin from the sac attached to the stinger. Ice also will help ease the swelling of stings.

---

Many spider bites can be dangerous. Victims of spider bites should be treated by a doctor as soon as possible.

---



If a tick has attached itself, grasp it with tweezers close to the skin and gently pull until it comes loose. Do not squeeze, twist, or jerk the tick, as that could leave its mouthparts in the skin. Wash the wound with soap and water and apply antiseptic. After dealing with a tick, thoroughly wash your hands and any affected area to help prevent Rocky Mountain spotted fever or Lyme disease, bacterial infections that are spread through contact with infected ticks. If redness develops in the bite area, see a doctor.



Whenever you go fishing, taking a few precautions can help make your outing a fun, safe, and comfortable one. By anticipating what can happen (such as exposure to cold or windy conditions), you can help prevent and mitigate (lessen the impact of) just about any type of mishap. You will also be in a better position to respond quickly and appropriately should a mishap occur. Remember to:

- Go with a buddy, and always tell your parents or guardian where you are going, who is going with you, and when you expect to return.
- Before heading out, check the weather forecast to make sure the climate and conditions will be safe wherever you plan to fish.
- Dress appropriately for the weather and activity, such as using sunglasses, and wearing a personal flotation device if you will be afloat.
- Drink plenty of water; stay hydrated in warm *and* cool weather.

## Puncture Wounds

Puncture wounds can be caused by splinters, nails, and just about any sharp object, including the sharp pectoral and dorsal fins of some fish species. Such wounds are hard to clean. To treat a puncture wound, use sterilized tweezers if necessary to remove the sharp object. Encourage the wound to help flush out dirt or other particles. Clean the injury thoroughly with soap and water and rinse well with clear water. Allow the wound to air dry, and cover it with a clean, dry dressing.

Fishhooks also can cause a nasty puncture wound. Always be aware of the path of your fishing rod and line when you cast to prevent the hook from catching on anything—especially another angler! Never try to remove a hook that is lodged in the face or near an eye, artery, or other sensitive area.

If you or someone else gets hooked, cut the line to keep the hook from getting further embedded. If only the point of the hook enters the skin and the barb has not taken hold, you can safely remove the hook by backing it out. If the barb becomes embedded, it's best to let a physician remove it. If medical help is not available, try this method:

1. Tie or wrap a length of strong string or fishing line around the bend of the hook.
2. Press down firmly on rear end the shank of the hook, next to the bend, to free the barb.
3. Maintain pressure on the shank, and jerk firmly on the string in the direction the hook entered.

If the barb is visible above the skin, use this method:

1. Cut off the barbed end with wire cutters or pliers.
2. Back the shank of the hook out through the entry wound.

After removing the hook, wash the area with soap and water and cover it with a dry adhesive or gauze bandage.

For any puncture wound, be sure to see a physician about the possible need for a tetanus booster shot and to help prevent infection.

**Back out hook if barb has not taken hold.**

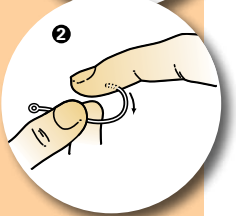
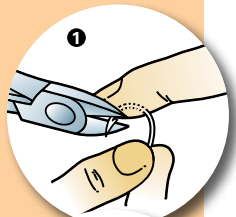
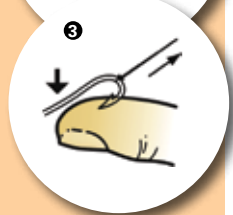
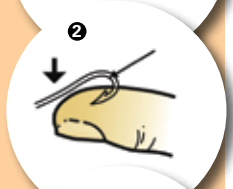
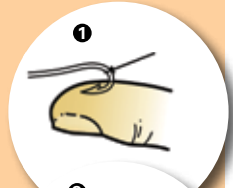



# The Nature of Fish

Fish are highly specialized aquatic creatures, amazingly constructed for living in water. Here are some interesting facts about fish.

- They are cold-blooded—their body temperature is about the same as the water around them.
- All fish are covered with a protective mucus or slime on top of their scales.
- Scales are protective plates that cover the skin. When a scale is lost, its “pocket” can become infected before the skin heals and a new scale develops.
- Scales develop annual rings much like those of a tree. A fish’s scales can help determine its age.
- The fish’s muscles and fins are designed to propel them through the water in search of food and to help them escape from predators.
- Fish breathe mainly through gills that absorb oxygen from the water and circulate it into the bloodstream while simultaneously removing carbon dioxide from the fish.

Most fish reproduce by the female laying eggs that the male fertilizes in the water. Some fish reproduce through live birth. The females of some species might lay many thousands of eggs, while some other species lay only a few hundred. Fish have the senses of sight, taste, smell, hearing, and touch, as well as other special senses to help them survive.

---

Some fish species are especially smart. Any experienced angler who has tried to catch the “old lunker” that has lived in the same pool for years will swear to that.

---



## Parts of a Fish

**Anal fin.** Used for balance and swimming.

**Caudal fin.** Used in swimming, particularly when a fish needs a quick thrust of speed.

**Eye.** Most fish have monocular vision—each eye sees separately, offering a wide field of view.

**Gills.** Respiratory organs used for breathing.

**Jaws.** Bony appendages that form a fish's mouth. They may be equipped with teeth so that a fish can grip its prey while feeding.

**Lateral line.** A sensory organ that detects sound and movement.

**Pectoral fin.** Used for stability, locomotion, and steering.

**Pelvic fin.** Used for steering and stability.

**Scales.** Transparent protective plates growing from the skin that can be replaced if lost.

**Soft dorsal fin.** Used for balance and forward movement.

**Spiny dorsal fin.** The forward fin, supported by sharp spines, is used for balance. The spines also protect the fish from its predators.

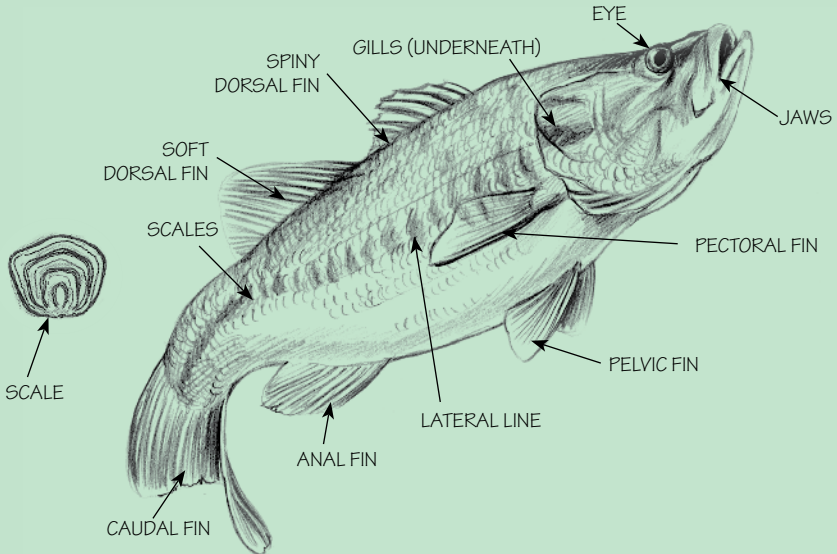

## Toothy Fish

Beware! Some common fish that you may catch, like the pike and pickerel in ponds, or bluefish in salt water, have very sharp teeth. Do not “land” them by grasping their mouth. Their teeth are there for snatching their prey—not your fingers.



## The Food Chain

As you practice the sport of fishing, you will learn about the watery world of fish, a complex environment that provides the food fish eat. At the bottom of the chain are plankton—minute creatures that are eaten by other forms of aquatic life, including some of the fish. In freshwater, there are countless insects that creep, crawl, and live in the water, eventually climbing or flying out of the water to mate, drop their eggs, and start another cycle of life. Fish and other creatures feed on these insects. In the sea, phytoplankton, zooplankton, small crustaceans, and smaller prey fish form the basis of the food chain for larger fish.





---

Large predator fish may eat insects, frogs, crayfish, and other fish—even members of their own families.

---

Crayfish hide under rocks and eat anything alive or dead they come across. Tadpoles swim in the shallows, developing into frogs that live on the shorelines. Small fish, including minnows, eat smaller forms of aquatic life and in turn are eaten by larger forms. The lures you use will imitate these forms of food.

The food chain starts with the smallest being eaten by larger creatures. In turn, those critters are eaten by something else. At the top of the chain are fish and the creatures that feed upon fish, including eagles, ospreys, mink, otters, bears, and, of course, humans.

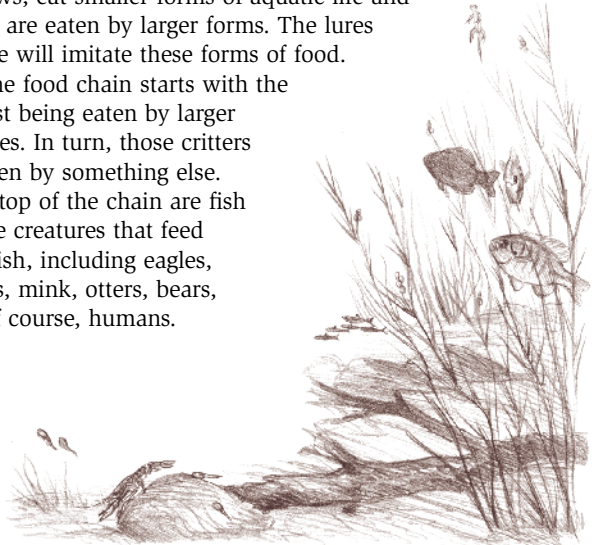

## Reading Nature's Signs

Locating lakes and streams where there are fish is easy. Every state conservation department has lists or maps showing all the fishing waters and which types of fish are in them. Tackle shops, sporting magazines, and friendly anglers are your most convenient sources of information on where to fish. Don't be shy in asking for information about local fishing spots. But once on the water, where are the fish?



### Fish Movement

Gamefish often come to the surface, sometimes leaping clear out of the water for food. The experienced angler searches for signs as to how a fish is feeding—whether a fish is surfacing or seeking food just beneath the surface. The angler is alert to the flash of sun off fish scales underwater or to the movement of a fish's shadow.

### Insect Activity

Insect life hatches continually year-round. The appearance of insects such as mayflies and caddis flies indicates that an abundance of larvae is crawling and swimming below, which means that fish are probably feeding on them.

---

Many freshwater fish feed on insect larvae year-round. In saltwater, small fish, worms, small shrimp, and other crustaceans satisfy the same ecological equivalent.

---



## Where to Find Fish

Fish can be found just about anywhere there is clean water. Fish live in bodies of water as small as a pond or as large as the ocean.

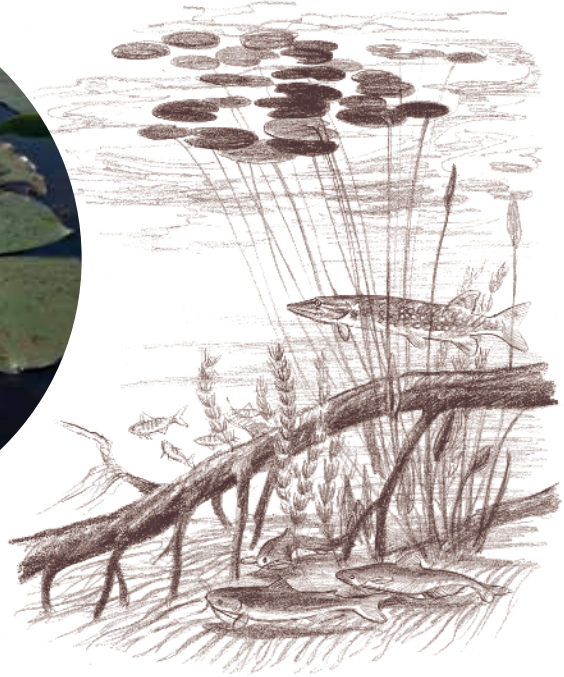

**A pond can have many species of fish at all depths.**

---

Some pond owners plant lily pads or other vegetation to provide shade, cover, and places for fish to congregate so they will be easier to catch.

---

### **Ponds**

Properly managed ponds can be high producers of fish, providing excellent angling. Most ponds contain gamefish such as bluegills and largemouth bass along the shoreline, adjacent to weed cover, or in the colder deep waters. Ponds are relatively easy to fish because they are small.

In hot weather, gamefish may seek the deeper areas. Fishing at varied depths is one way to locate schools of fish. Many ponds have bullheads or catfish living at the bottom. These fish are relatively easy to catch on live bait fished down to where they live.

## Lakes

Lakes are larger bodies of water and a popular place for sportfishing. Most anglers can find several lakes within easy driving distance that provide a variety of environments for fish.



**Shallows.** Most of the food and most of the cover, such as weeds and sunken trees, are found near shore. Thus, most fish at times will be found near the shallows, moving in and out to feed. Some species, such as panfish and pike, tend to spend most of their time in shallow water. Others, such as the bass and walleye, move in and out at different times of day and under different conditions of weather and temperature.

**Breakline.** The breakline is where the shallow waters drop off toward the deep water. This is a place where many fish tend to congregate, waiting for the opportunity to feed.

**Structure.** Rocks, ledges, reefs, bars, and sunken obstructions, found in or near deep water, can be holding spots for fish schools. These hangouts are used by various species between times when they move up to the breakline or into the shallows to feed.

---

Find out where fish are most likely to feed—their “dining spot”—and concentrate your angling efforts there.

---

### Streams

Stream fishing for trout and salmon has a special attraction to anglers who learn to fish moving waters. The constant movement of a stream presents a natural challenge for an angler. Depending on the time of year, streams can be full of trout or salmon returning from the sea to spawn. These fish draw anglers from miles around to try their luck.



**Rapids.** Where water rushes into a pool, crashing down over the boulders or thundering in from a waterfall, fish tend to gather. These are places where food collects and can easily be captured by the fish. Rushing water is highly aerated, which creates a cool, oxygen-filled environment. Some fish such as trout regularly live in such places, which are hatching sites for a variety of insects that trout prefer for food.

**Cutaway Banks.** Fish tend to hide where stream currents have carved holes under a bend in the shore, particularly where there are trees and exposed roots. Deep, quiet channels also are good spots to locate fish in streams.

## Big Water

With an environment as big as the ocean, you can expect to find bigger fish. Deep-sea fishing for some of the world's largest species has become a popular sporting pastime.

**Surf.** Some spectacular angling is available on the edge of the nation's two oceans and along the coast of the Great Lakes. Long casts require specialized tackle.



---

Extreme care must be taken when waves get big, during tidal movements causing undertow, or when slippery rocks are present.

---

Surf fishing today is most often done with heavy-duty spinning tackle, although some saltwater casting is done with bait-casting outfits. Lures or baits require a long rod with plenty of backbone to get out beyond the shallows to where the fish lie. Surf rods are built with long handles for casting with two hands, using a sweeping motion, overhead and to the side.

Hundreds of lures are designed to take the variety of sport fish found in salt water. Various types of live bait and cut-up bait also can be bottom-fished for saltwater species. In the Great Lakes, surf angling is highly effective for salmon and trout. Chest-high waders or hip boots may be necessary to get into the edge of the surf, although in warm weather many wet-wade.



Most saltwater anglers beach small fish and use a net to land the larger ones so the fish can be released alive. Great Lakes anglers most often use large landing nets, preferably with a companion handling the net while the angler concentrates on the fish.

**Offshore.** Trolling and still-fishing or drifting are the usual uses of boats in salt water, the Great Lakes, and the nation's big impoundments. Offshore saltwater trolling for swordfish, tuna, sailfish, shark, and other big species requires large fishing craft and heavy tackle. Most of this type of fishing is on charter boats with experienced guides.

A variety of saltwater fishing can be done with outboard craft and medium-weight tackle for anglers who may troll, cast, or bottom-fish. Party boats with experienced captains take large numbers of anglers to reefs where gamefish are taken on baited hooks dropped over the side.

Great Lakes trollers have specialized equipment—planing boards and lead-weighted downriggers—designed to get lures out to the sides of the boats or deep down. Sometimes the boats are allowed to drift, with the anglers simply jigging lures up and down or sending live bait to swim around below.

## Where Fish Hide

Fish hide for two principal reasons: to conceal themselves from predators and to ambush unwary prey swimming past. In the shallows, fish are found around weed beds, underneath overhanging trees and brush, near docks, and where rocks jut out from the shore. In deep water, fish are quite often found around clusters of big boulders where they conceal themselves in the shadows.

## Factors Affecting Fish Behavior

Since before recorded history, anglers have studied fish, trying to determine what conditions cause fish to bite more readily. There is a definite correlation between weather and fish action, usually with a spurt of feeding just before a weather front arrives. A drop in atmospheric pressure, measured on a barometer, can anticipate fronts. A barometer measurement is in inches of mercury, abbreviated as *inHg*. Normal barometric pressure is 30 inHg at sea level. Low pressure is below 30 inHg, and high is above 30 inHg. An approaching low, with the barometer declining, often indicates an approaching storm. Similarly, a rising barometer often indicates clearing weather.

Water temperature has a definite effect on fish. For instance, many trout species cannot endure water temperatures much greater than 70 degrees Fahrenheit for extended periods of time. A sudden drop in temperature often will cause fish to stop biting. This is quite common after a storm passes. Rising temperature often causes fish to bite. In coastal areas, the tides have a strong influence on fish behavior.



**Sunken trees that have fallen into the water are sure hangouts for almost all species of gamefish.**

## Seasons

Spring usually finds the water cold but warming, with the best fishing on the warmer days. Spring is when many species are spawning, a time when they tend to strike lures quite readily.

More fish are caught in summer than in any other season. It is a time when more anglers are fishing and also when the water temperature is rising, speeding up the metabolism of fish and causing them to feed more.

Fall can provide some excellent fishing, particularly when there are warm days and cool nights. Cold fall days often are not productive.

Winter usually is associated with ice fishing. Water temperature under the ice is low but usually stable. Some species of fish—trout, pike, perch, walleye, and panfish—bite readily in winter.



## Why Fish Bite

Fish react to various stimuli, not all of which have been determined. But when a bait or lure sets off the trigger, the fish strikes.

All species of fish have certain times of the day when they feed. Some of the periods seem to coincide with phases of the moon and tides, some with weather, some with time of day. Early morning and late evening are usually times when fish are active, but there are other times, even after dark.

In most instances fish bite because they are hungry. As an angler, you will imitate the kind of food you believe will attract a feeding fish. Your lure may imitate a minnow or a mayfly; your style of fishing may be with a spinning rod, bait-casting reel and rod, or fly-fishing.

Schooling fish, such as white bass, go on feeding frenzies, chasing swarms of baitfish and gulping down as many as they can. Then they stop abruptly and cruise along ignoring the same baitfish they were chasing a few moments before.

Fish can be spooked or turned off by the intrusion of a noisy boat or a noisy wader, by a badly presented bait or lure, by too big a hook, by a heavy line or leader that may be visible, or by a shadow falling on the water. There is an old saying, "If you can see the fish, they can see you." And sometimes they just won't bite, period.

With experience, the angler learns when and where each species is more apt to take a bait or lure.



**Rainbow trout**



**Arctic grayling**



# Freshwater Fish

Lakes, ponds, rivers, and streams are home to many hard-fighting species. Fishing can be done from the shore, dock, while wading, or by watercraft such as a motorboat, kayak or canoe.

## Walleye and Perch

Walleye and perch are among the finest gamefish in North America. The walleye, the largest member of the perch family, is

particularly prized because it grows to a large size and is very tasty. Many anglers troll for walleye, using minnowlike lures weighted down deep, jigs tipped with live bait, spinner-and-bait combinations, or just live bait with a slip sinker. Slowly trolling over sunken bars, alongside ledges and weed beds, and over sand flats (particularly those parallel to the breakline) can be effective.



**Walleye**

In early morning and evening, walleye may be taken by casting lures; excellent catches of walleye can sometimes be made late at night on slowly retrieved crankbaits. Numerous walleye are caught every year by still-fishing live bait either on the bottom or with a slip bobber.

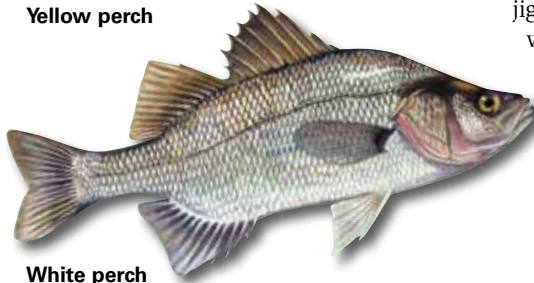

**Yellow perch****White perch**

Yellow perch are abundant and willing to bite almost any-time. These fish provide a lot of action when a school is located. The most popular method of perch fishing is with minnows, worms, or leeches on a small hook below a bobber. Tiny jigs,  $\frac{1}{8}$  to  $\frac{1}{16}$  ounce, with a piece of worm on the hook, often do the trick. In the spring, perch gather where streams enter lakes and where there are dams in rivers. They may be taken in large numbers with a streamer fly or a small spinner fished on a fly rod.

While perch are not great fighters, they are fun to catch in large numbers and are a tasty fish fry.

## Sunfish

This year, a million American young people will be introduced to the sport of fishing, and most of them will catch a species of sunfish. There are seven families of sunfish. The most common: bluegill, pumpkinseed, redear, warmouth, crappie, rock bass, largemouth bass and smallmouth bass.

Sunfish include species that are called by dozens of different common names throughout the U.S. and can be referred to as panfish—aptly named, as many species of sunfish are some of the tastiest in the frying pan. They also are fun to catch, and some are ferocious battlers, despite their relatively small size. In Southern states, sunfish are also called bream.

While panfish may be taken on almost any kind of pole, line, rod, and reel, catching them on a fly rod or ultralight spinning tackle is great sport. Panfish are highly susceptible to flies and tiny jigs. They also bite small panfish popping bugs, size 10 or 12, during the warm months when insects are hatching.

**Bluegill and Similar Sunfish.** The male bluegill, like many of the sunfishes, has a shiny, dark blue patch on the edge of the gill cover. Also, like its sunfish cousins, it is brightly colored. The bluegill has purplish sides with black bands and a bright yellow or orange throat. It has a small mouth, so small hooks are required to catch it. Bluegill are found just about all over the United States and grow to 2 pounds, although 1-pounders are considered a trophy. They are among the toughest fighters of the sunfish clan. While sunfish may be taken on almost any kind of pole, line, rod, and reel, catching these bantamweight warriors on a fly rod or ultralight spinning tackle is great sport. Sunfish are highly susceptible to flies and tiny jigs. They also bite small popping bugs, size 10 or 12, during the warm months when insects are hatching. Often while targeting bluegills, Scouts may catch other common sunfish—like pumpkinseed, redear, and warmouth—that live in the same areas of a lake or pond. Live bait such as worms or crickets are very effective when fishing for sunfish.

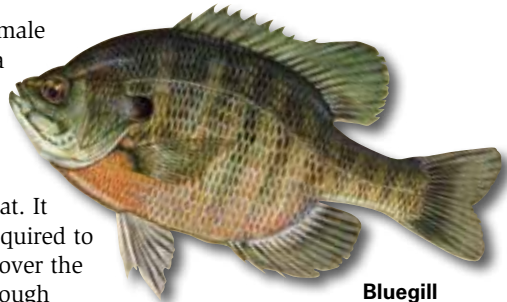

Bluegill

**Rock Bass.** The rock bass is a brassy-colored sunfish with rows of black scales and distinctive red eyes. A stubby fighter growing to 2 pounds that will strike almost any kind of live bait or artificial lure, it likes to hang out around old bridge piers, docks, boulders, and weed beds. Except in the late fall when it goes deep, the rock bass is a shallow-water feeder that likes to take minnows and bugs near the surface.

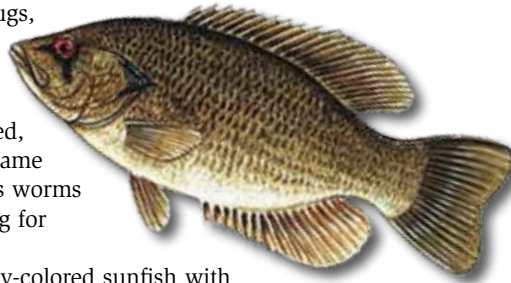

Rock bass

**Crappie.** White and black crappies grow to 4 pounds, although a 2-pounder is considered a trophy in most areas. They feed mainly on small minnows and insects and will take small spinners, lures and streamer flies without hesitation. Crappies are often found close to structure. Be aware that crappies have a paper-like mouth and must be fought and handled carefully so that the hook does not pull loose. Crappies are excellent eating.



Crappie

## Largemouth Bass

No fish is more aptly named than the largemouth bass. Its jaw extends well back past its eye, and when it opens its mouth to swallow something, it seldom misses. Because of its ability to take a wide variety of lures and because it often strikes explosively on the surface, the largemouth is one of the most prized and gamefish in North America. The first reels and casting rods made in the United States were tailored to bass fishing.

Bass are a great sportfish, and many anglers release the bass they catch, perhaps keeping one or two small ones for supper. Small bass are excellent eating; big bass are not as good.



**Largemouth bass**

Largemouth can be caught on bait-casting, spin-casting, spinning, and fly tackle. They will hit topwater lures, crankbaits, Woolly Worms, and bottom-bumping jigs. Weedless spoons and spinnerbaits that will not snag on vegetation when fished through the lily pads, often are productive. Realistic plastic lures that imitate minnows, worms, crawfish, frogs, salamanders and insects are effective. Largemouth also will hit live bait such as minnows, frogs, leeches, and crayfish, which are life-forms that are naturally found in their habitat and are part of their accustomed diet.

In the South, largemouth can grow to 20 pounds or more. In the North, 10 pounds is a record-breaker. Largemouth are structure-oriented fish, meaning they hang around brush, fallen trees, weedbeds, and ledges, usually in fairly shallow water.

Where they are heavily fished, they become cagey, and the angler must be careful, quiet, and skillful to be successful.

## Smallmouth Bass

Averaging between 4 and 6 pounds, the smallmouth bass has been described as “pound for pound, the game fish that swims.” Many anglers will argue for other species, but there is no question that this snub-nosed, jut-jawed warrior of the cold water is a foe to test the tackle of any angler.



Smallmouth once were confined to the eastern United States but have been stocked over all of the northern states, much of Canada, and parts of the southern U.S. Night crawlers, leeches, minnows, frogs, and hellgrammites (a type of aquatic insect larvae) are all natural food for this fish. They also will hit a wide variety of spinners, crankbaits, topwater lures, flies, plastic worms, bugs, and jigs.



**Smallmouth bass**

However, unlike the largemouth, which often will hit a fast-moving lure, the smallmouth likes its bait moving slowly, with frequent pauses and twitches. When it does strike, however, it strikes like lightning. The battle is spectacular, playing out as much above the surface as below. Its preferred hangouts are fallen trees, underwater cabbage beds, rock ledges, and deep boulder piles. In the spring, the smallmouth is up in the shallows, but in the summer, it may be down 10 to 30 feet. In the late fall, the smallmouth schools at 40 feet.

The easiest way to distinguish the smallmouth from its largemouth cousin is by the upper jaw. In the smallmouth bass the jaw comes to a point just to the eye. In the largemouth, the upper jaw ends behind the eye. Also, smallmouth are yellow or tan with brown markings. The largemouth is a greenish-gray color with black markings. Both fish are known as black bass.



## Striped Bass

Striped bass are basically saltwater fish that range along the East Coast from Maine to Georgia and are a favorite of anglers who fish in the surf. Stripers have also adapted to freshwater to become a productive inland gamefish.



**Striped bass**

Striped bass are strong fighters and usually are taken on light saltwater tackle. Most stripers are caught on live shad minnows, although casting heavy jigs, Clouser minnow flies, and spoons can work well when the fish are feeding. Anglers locate schools of stripers by watching birds circling baitfish chased to the surface by feeding bass.

## Catfish

Smooth, tough-skinned, long, lean, and built for power, the catfish family is widespread in North America. Catfish are found in clear, icy waters of the North as well as the warm, muddy streams and bayous of the South. They are highly tolerant of water temperature fluctuations and can withstand turbid water, even some pollution. They are relatively easy to catch, are fierce fighters, and make for fine eating when properly prepared. Be careful: All catfish have sharp spines in the pectoral and dorsal fins that can cause a painful wound to the unwary or careless angler.

Channel catfish are sleek and highly prized. They can grow to 30 pounds or more, but the average is 2 or 3 pounds. Flathead catfish and blue catfish regularly grow to more than 40 pounds, some reaching 100 pounds. The most common catfish is the much smaller bullhead—a dweller of small streams, ponds, and sloughs. Thousands of bullheads are caught each year by anglers with no more than a hook, line, and bait. Larger catfish are found below dams, in riffles, beneath undercut banks and logjams, and in deep holes and channels. The best way to catch them is to fish the bait on bottom.

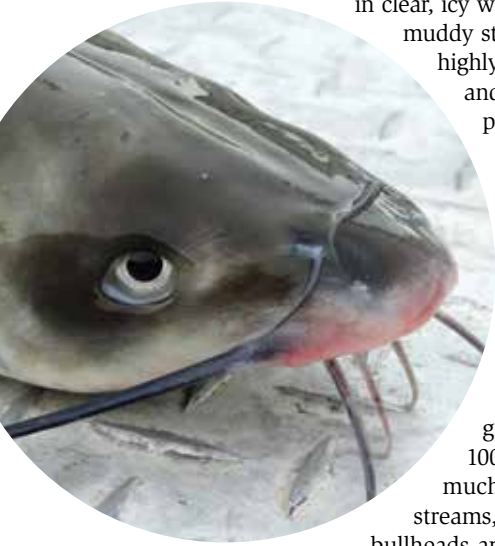

**Bullhead catfish**

## Catfish Bait

Nearly any bait, alive or dead, will take a catfish. Channel cats, at times, will strike a lure as savagely as a walleye. Some favorite catfish baits are cut-up smelts or other small fish, worms bunched up on a hook, clam meat that has been allowed to mellow in the sun, and crayfish tails. Catfish also like liver, chicken entrails, and cheese. Commercial “stink baits,” which have a strong odor, also are good.

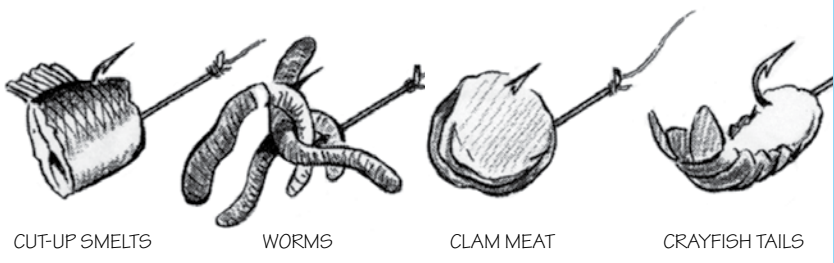

## The Pike Family

Big, sharp-toothed, and mean-tempered, the fish that make up the pike family have a common trait: They strike first and ask questions later.



---

Pike must be carefully handled to avoid contact with their teeth and gill rakers.

---



**Northern pike**



**Muskellunge**

---

Members of the pike family are excellent eating but are bony.

---

**Northern Pike.** Most common is the northern pike, found over a large part of North America. They may grow to 50 pounds. All of the pikes prefer large, flashy lures such as spinners, spoons, silvery floating-diving plugs, and noisy surface baits. They strike big minnows and will readily take strips of sucker meat or frozen smelts.

**Muskellunge (Muskie).** Biggest of the pike family, these fish grow to more than 60 pounds. The true muskie is light olive with brown spots. Hybrid muskies are light olive with brownish stripes. The hybrids are muskie-northern pike crosses, called tiger muskies. Muskies are not nearly as common as northern pike and are not as easy to catch, so they are much sought after as trophies.

**Chain Pickerel.** These are a smaller pike cousin, yet are more commonly available. They are best caught during the day on live bait or lures and are found in shallow, weedy lakes.

## Trout

Trout are a cold-water fish, needing water of less than 70 degrees. For sheer beauty, the members of the trout family are hard to beat. They are sleek, without large scales, colorful, and designed to swim in moving stream waters.

**Brook Trout (Char).** A dark-green back with yellowish tracks, spotted sides with bright-red spots, red fins, and a white underside mark this all-American warrior. Brook trout are found anywhere from tiny beaver ponds to the great rivers of the North. In lakes it grows to 7 or 8 pounds, but the average brookie weighs less than a pound.



Brook trout

**Rainbow Trout.** Aptly named for the bright red streak down its silvery side and its bluish-green back, the rainbow trout is not only a handsome fish but also one of the most spectacular leapers among freshwater species.

There are many varieties of rainbow trout, some growing to more than 20 pounds.

The migratory steelhead, a fish that spawns in streams but spends most of its life in salt water or the Great Lakes, is a cousin.



Rainbow trout

**Brown Trout.** This European import has taken hold in many of the warmer streams that will not support native American species. It is stubbier than most trout, yellowish-tan with brown and red spots, shy, and sometimes difficult to catch. Planted in the Great Lakes, it can grow to more than 20 pounds.

All types of flies, small spoons, and spinners are effective for trout fishing. Where regulations permit, live bait for trout includes worms, minnows, and insects. Salmon eggs also can be good bait. When caught, trout should be either released or killed and kept in a creel (a special bag or basket), not in warm water where they will turn soft and deteriorate quickly.



## Lake Trout and Salmon

While salmon always have been a popular sportfish in saltwater and in the coastal rivers, new fisheries occurred in the Great Lakes when coho salmon were first stocked in Lake Michigan to control the invasive alewife. There are now chinook and pink salmon to catch in the Great Lakes, along with native Lake Trout.

### Trolling

This is the most popular method of taking both lake trout and salmon. Heavy-duty spinning tackle is most often used with lures pulled behind the boat near the surface or down deep, depending on where the fish are. Spoons and large, minnowlike lures in a variety of colors—from blaze orange to fluorescent green—are popular. **Downriggers**, wire lines with heavy lead weights, are used to get the lures deep. Planing boards that float and run parallel to the boat often are effective in getting lures out to the side. Trout and salmon also may be taken by drifting while jigging heavy jigs below the boat.

### Casting

Anglers without boats take large numbers of salmon and lake trout by casting offshore on points and at the mouths of rivers. In late summer, the salmon begin their fall spawning run. Lake trout follow a short time later. Long rods, 9 to 10 feet, are used with light saltwater reels to cast the lures far from shore.



## Ice Fishing

When winter comes and the lakes freeze over, a different type of fishing begins. Some species of fish—bluegill, crappie, perch, pike, walleye, and trout—may be caught readily through the ice.

The bulk of ice fishing is for species of panfish and is done with lures. The lures are bits of chromed metal, painted lead, or plastic designed to look like flickering minnows or struggling insect larvae in the water. They are used in conjunction with real insect larvae or tiny minnows and are jigged near the bottom.

Pike, walleye, and trout usually are taken on larger metal spoons, lures, and jigs baited with live or dead minnows. Most anglers use regular spin- or bait-casting reels on special, short ice rods. The drag is usually set on the light side so that a large fish can be played without the line snapping. Fish caught through the ice in the winter can be put in the bucket or box seat to take home. No fish, bait, or other trash should ever be left on the ice.



The standard outfit for ice fishing includes short rods; monofilament line; ice flies; spoons, lures, jigs, and bait; an **ice auger** to drill holes; a skimmer to dip the slush and ice chips out of the fishing hole; a bucket or box to sit on; and plenty of warm clothing.

Thin ice can be dangerous. Your merit badge counselor can tell you more about the hazards associated with ice fishing. Before you go ice fishing, check with local conservation officers for ice conditions if there is doubt about safety.





# Saltwater Fish

The ocean coastline, including the estuaries of rivers flowing in, offers a variety of sportfishing from piers, wading the surf or flats, casting from outboard skiffs, and trolling or bait fishing from big water cruisers. Some of the larger trophy fish, such as the tarpon, are wild acrobats and fun to catch but should be released because they are not particularly good to eat.

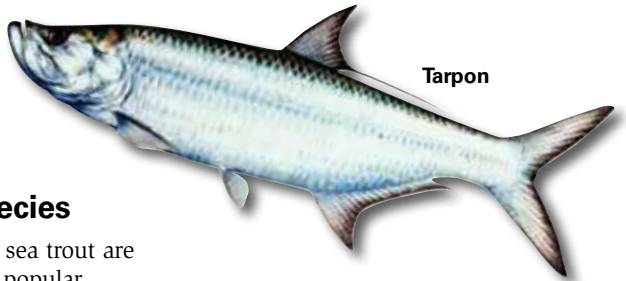

Tarpon

## Shallow-Water Species

The pompano and spotted sea trout are two shallow-water species popular with anglers. Pompano are among the tastiest saltwater fish. They also are frantic battlers and may be taken by casting or trolling small jigs or flies, plain or baited with sand bugs.

Sea trout (sometimes called weakfish) are abundant and easily caught where they swarm in coastal bays and lagoons and at river mouths. Using drifting or casting jigs baited with fresh shrimp is a surefire method. Trout also will hit spoons, surface lures, and fly rod streamer flies.

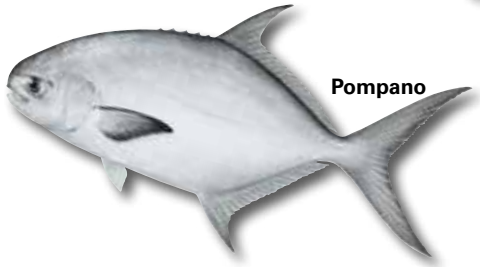

Pompano



**Yellowtail**

## California Yellowtail

This exciting fish, also called the amberjack, may grow to more than 60 pounds, but the average is 10 to 20 pounds. Live sardines, cast or trolled, are the most popular baits, although yellowtail sometimes will hit trolled lures. They are considered a fairly good table fish.

## Snapper

A shallower-water fish that hangs around coral structures and often invades southern coastal streams, the mutton snapper runs from 5 to 20 pounds and is rated highly for food qualities. Good fighters on light tackle, they strike jigs, flies, crankbaits, and surface lures, along with shrimp and other live bait. They have sharp teeth, and most anglers use wire leaders for these fish. The red snapper, a deep-water cousin, lives farther north and usually is caught on still-fished cut bait. It is superb eating.



## Catch and Release—With Care

Scouting's founder, Lord Baden-Powell was an avid angler and a pioneer of **catch-and-release fishing**. He wrote: "When you catch your fish as I do—only keep those you especially want for food, put back the others the moment you have landed them." Catch and release prevents overfishing, helps lengthen the fishing season and supports the conservation of fish.

- Use artificial lures with barbless single hooks. Fish tend to swallow live bait more deeply, and barbless hooks are easier to remove and generally do less damage than barbed hooks.
- Play the fish, then release it as gently and quickly as possible. Do not play the fish to exhaustion, or it might not recover.
- If the fish has swallowed the hook, cut off the line as close to the hook as possible. Never try to remove a deeply embedded hook because you may damage the fish beyond recovery or make it a more vulnerable prey.
- Whenever possible, avoid removing the fish from the water. Prepare your camera for pictures first; hold up the fish for a quick photo, and release it immediately.
- Only use a landing net made of soft nylon or soft rubber and not hard mesh, which can damage the slime that covers the fish and helps protect it from disease.
- If you must handle the fish, wet your hands first. Dry hands will remove the fishes' protective (mucus) slime coat, exposing it to disease. Support the fish horizontally—never vertically—in the water across the back and head, avoiding the eyes and gills. Before releasing, revive the fish gently by holding it facing the current in streams or rivers or facing deep water in ponds and lakes until it swims away.



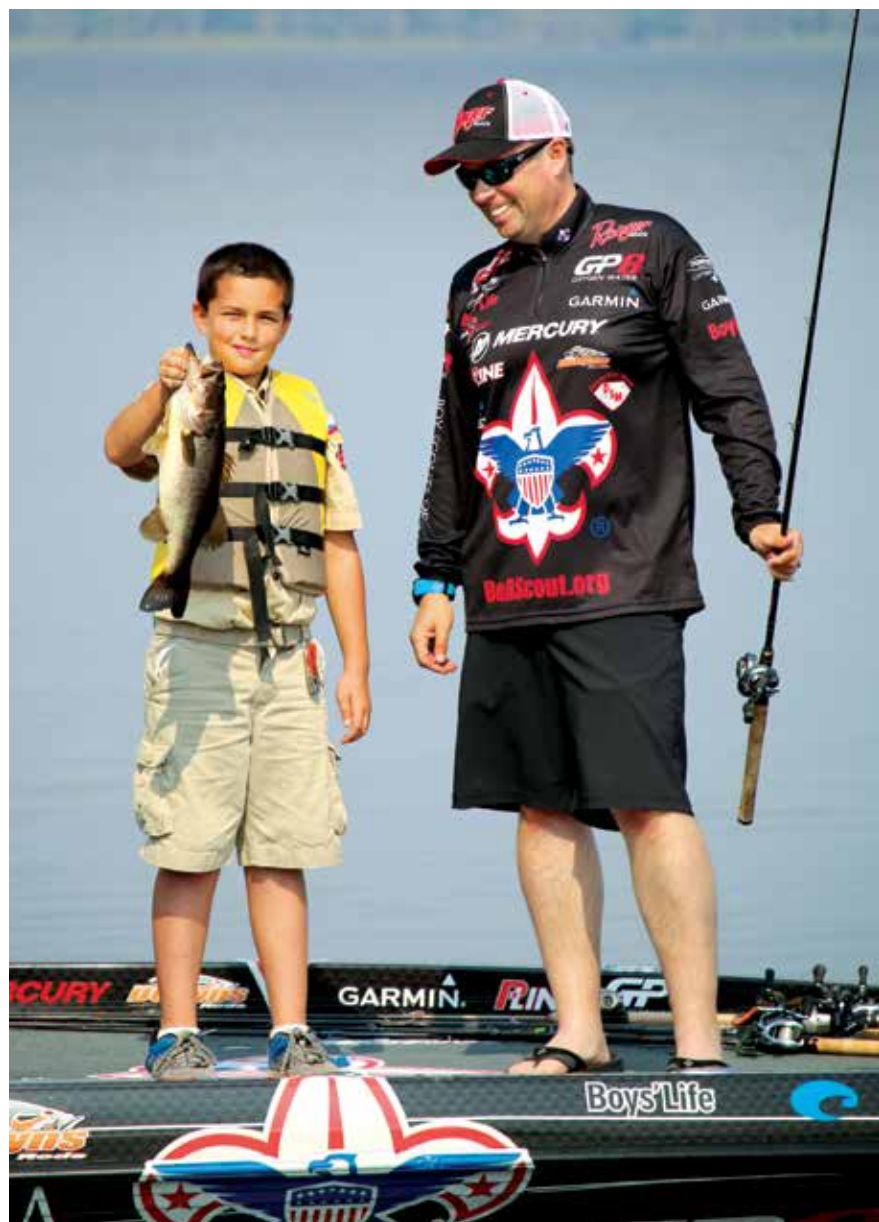

A Scout with fishing professional Tom Redington.

# Balanced Tackle

When the rod, reel, and line are correctly matched to handle lure or bait of a given weight, they are considered to be in **balance**. When in proper balance, they allow the angler to deliver the lure or bait with accuracy within the desired distance. Modern tackle manufacturers are continually experimenting and upgrading their rods, reels, and lines to create more efficient tackle for easier casting.

Fly-fishing requires that the rod be balanced with matching line, the reel mainly having the function of line storage. Fly rods are usually marked with numbers indicating which line works best on that particular rod.

Balance also applies to the rod you select when you target fish you hope to catch. Use a lighter rod for smaller fish and a heavier rod to match better with larger fish. Catching small fish on a heavier rod is not as much fun. Similarly, catching larger fish on a very light rod may lead to an overly fatigued fish that might die after release.

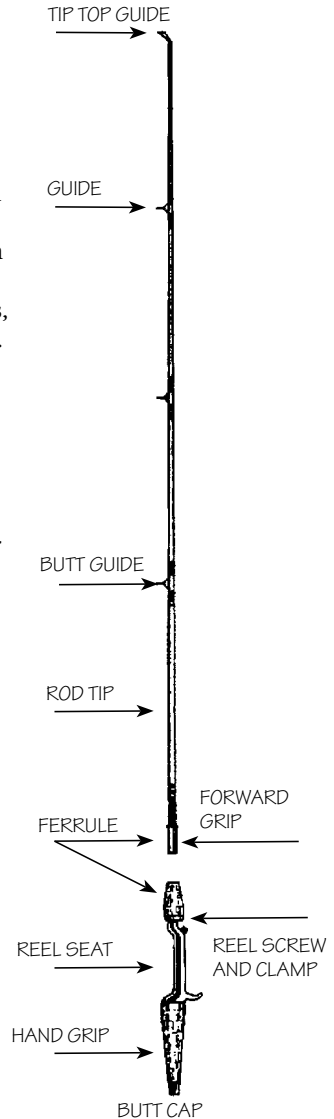
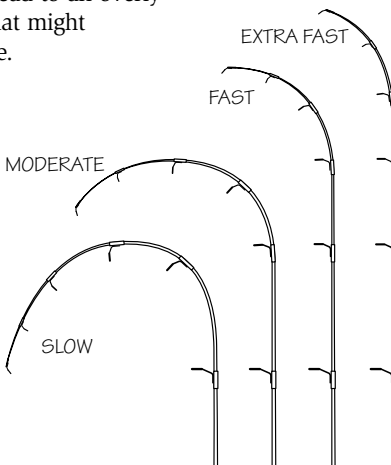



Before casting,  
always check  
behind you—  
you want to  
catch a fish, not  
another angler!

---

Equipment used in saltwater fishing is much the same as the equipment used in freshwater fishing except that every piece of tackle designed for saltwater fishing is more resistant to corrosion and is usually built on a larger scale: reels are huskier; rods can measure from 8 to 11 feet long; and lines and lures are heavier for handling many larger saltwater predators.

Tackle catalogs list rods and reels by weight and function, allowing the angler to make informed choices. Tackle dealers, tackle representatives at sport shows and demonstrations, and experienced anglers are all good sources of information on suitable tackle for the fishing of your choice.

The four types of reels most commonly used are the bait-casting reel, closed-face spin-casting reel, open-face spinning reel, and, for fly-fishing, the fly reel.

## Fixed-Line Fishing

Fixed-line poles are a first fishing pole for many youth. A fixed-line pole does not have a reel, and therefore is called a “pole” instead of a “rod.” Cane poles are usually made from dried bamboo. A crappie pole works the same way, but instead of being a fixed length pole of natural material, crappie poles typically telescope to a length from 10-16 feet, and are made of fiberglass or graphite.

To cast a fixed-line pole, hold the pole in your dominant hand, and hold the line with your other hand just above the hook or lure. Lift the rod with a sweeping motion and release the line to swing out. When the line is fully extended, bring the rod tip down to place the hook in the water. This is called a pendulum or swing cast. Combining the length of the pole and the line allows you to place the bait where you want to.

## Bait-Casting

Bait-casting is used by more experienced anglers. These outfits are very accurate and casts over 50 feet are relatively easy with practice and experience. The lure is flipped from the tip of the rod, pulling the line from the reel. The reel is on top of the rod and control of the cast is through use of the thumb on the casting hand. The lure is then retrieved by turning the reel’s handle. Bait-casting reels have a “level wind” mechanism that keeps the line even across the spool. If the line is not thumbed lightly during the cast there is a possibility the

line will overrun, creating a backlash. An adjustable drag allows a hooked fish to take line out under preset pressure so that quick rushes will not break the line.

Bait-casting is done with a wrist and forearm motion. The rod is held with the thumb holding the line secure. The rod is brought up sharply until vertical, the weight of the lure bringing the tip back to a one o'clock position. With an almost continual motion, the rod is stroked forward and the thumb releases the line, allowing the lure to shoot forward. The thumb should reapply pressure as the cast reaches the desired distance and before the bait or lure hits the water.

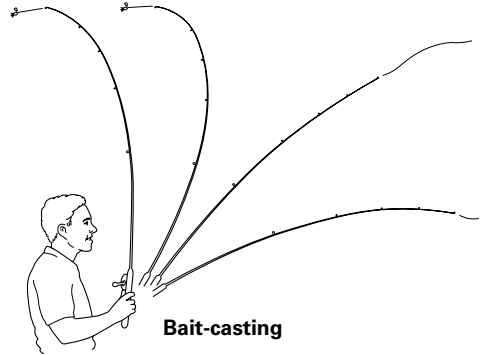

## Spin-Casting

Spin-cast outfits are good for beginners because they're relatively easy to use. Spin-casting reels have a fixed housing mounted on top of the rod. The reel has a push button which holds and then releases the line during the cast. During the retrieve, a pin on the rotating spinner head assembly winds the line back onto a fixed spool. Spin-casting reels have an adjustable drag that allows a preset pressure on hooked fish. These reels are very accurate and useful in hitting small openings in weed beds or around snags. However, learning how to master these skills takes practice.

The motion of the cast is very similar to the motion of throwing a paper airplane; the hand moves from just behind the head in a straight line until the arm is extended. The rod tip moves from being upright at the start to pointing forward at the end of the cast. The thumb button controls the release of the line. Pressing the button prior to the cast retracts the pin on the spinner head assembly and clamps the line, so once the button is pressed it needs to stay down until the release. Timing of the release is key to a good cast. As the rod moves forward the timing of the release allows the lure to carry the line freely to the target. The spin-cast outfit is very effective with live bait, artificial baits, lures and spinners.

## Spinning

Spinning outfits also may be used for trolling. The preset drag holds the line at a tension that will release on a strike from a heavy fish but will not release because of the motion of the boat or the pull of the current.

Although almost nonexistent in the United States before 1940, **spinning** has become a popular form of casting. The fixed-spool reel is mounted under the rod. The line is controlled with the index finger of the casting hand. The fingertip picks up the line as the free hand moves the spring-operated pickup arm, or bail, to one side. The rod tip is raised to vertical then swept forward, the index finger precisely releasing the line as the lure shoots out.

To stop the cast, the tip of the index finger touches the line against the spool and then the free hand flips the bail pickup to capture the line. The bail will flip automatically when the handle is turned, but this is generally not recommended. A roller on the bail lays the line back smoothly on the spool as the reel handle is turned. A drag adjustment screw on the front or rear of the reel controls the tension necessary to pull line from the reel when fighting a fish. Spinning tackle ranges from heavy-duty big-water outfits that require two hands to cast to ultra-light combinations that weigh only a few ounces. Because there is no movable spool, long casts can be made effortlessly with spinning tackle. Tiny lures may be cast accurately on threadlike lines and large lures may be cast long distances on the heavier outfits.

### Spinning

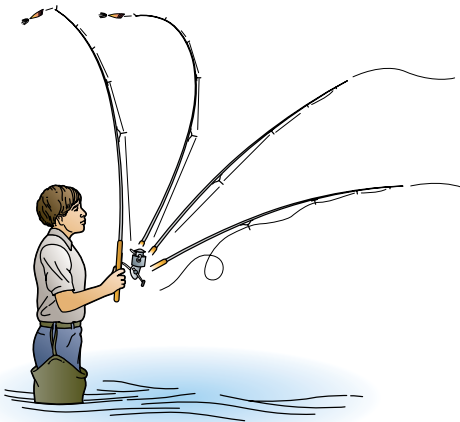

### Open-face spinning reel

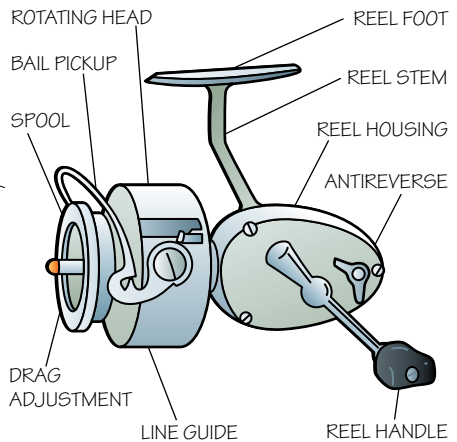

## Fly-Fishing

When **fly-fishing**, the angler typically uses a long, flexible fly rod to cast a plastic-coated line. The weight of the line, not the fly, carries the fly out. The fly imitates the prey upon which fish regularly feed (mayfly, caddis fly, stone fly, minnow, etc.).

Fly-fishing is a form of angling dating back hundreds of years to its origin in Europe. Early anglers had limited resources and used a line tied to the tip of a long, thin rod. Later a system of guides, fixed along the rod, was devised so that extra line could be released at the cast, allowing the fly to sail out much farther. A reel was fastened to the lower, butt end of the rod as a place to store extra line.

For the cast, a minimum of 15 feet of line plus the leader is stripped out in front of the angler. The rod is brought upward with smooth acceleration as the line is gripped firmly between the thumb and index finger of the non-casting hand. The line should sail upward and behind the angler in a loop. At that point, the rod tip is stopped abruptly at approximately 30 degrees beyond top dead center waiting for the fly line to fully unfurl behind the angler. At the precise moment the line is still airborne and flat behind, the angler applies forward thumb pressure moving the rod tip smoothly and firmly toward the desired casting location. When the rod tip reaches approximately 30 degrees forward of top dead center, the angler releases the fly line being held in the non-casting hand. With practice, the excess line shoots out and pauses briefly over the water, the leader straightens out, and the fly drops gently to the water's surface exactly where you believe a fish is likely to be!



**Many anglers tie their own flies for fly-fishing, like this Woolly Buggy fly. You can learn more about fly-tying in the *Fly-Fishing merit badge pamphlet*.**

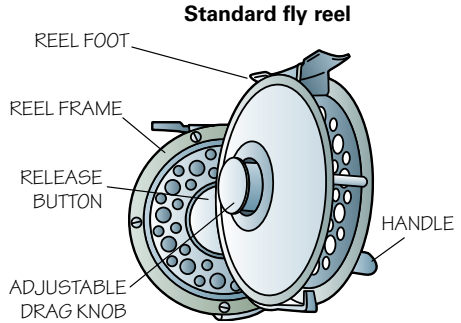

---

Fly rods are limber and light, weighing only a few ounces. The fly rod provides a maximum amount of leeway to a fighting fish. However, with skill, even large fish can be played and captured on a lighter weight fly tackle.

---

## Fishing Lines

Varieties of lines of different weights, diameters, and construction are available, made for different types of fishing—fly-fishing, spin-fishing, or bait-casting. Monofilament lines come labeled as nylon, which floats, and fluorocarbon, which sinks, allowing for different delivery of lures and baits. These lines come in clear, which is almost invisible to fish, and in colored lines for different conditions. Nylon and fluorocarbon monofilament lines are used when using a fixed-line pole, a closed-face spin-casting reel, or an open-faced spinning reel. Low-stretch braided lines are generally used in bait-casting and open-faced spin-fishing. Fly lines for fly-fishing are coated with a plastic finish to add weight. They come level or tapered to facilitate casting. Avoid the level fly line, as it is frustrating to cast.



No matter what type of line you choose for your rig, keep it in good shape by following these tips.

- Store fishing line at room temperature. Too much heat, sunlight, or cold can weaken the line.
- If a knot forms in monofilament or braided line near your rig, cut the line above the knot and at the rig, then re-tie the line. Recycle the cut end if possible, or dispose of it properly.
- Frequently check the last 10 to 12 feet of casting line for nicks and abrasions by running the line between your fingers. If the line feels too rough, cut the rough piece, retie your rig, and resume line fishing with fresh line.
- Dispose of used and broken fishing line responsibly. Do not discard monofilament or braided line on the ground; pack it out for the safety of wildlife. Many tackle shops offer recycling bins specifically for used fishing line.

## Knots for Fishing

Contrary to the thinking of many novice anglers, a simple overhand knot will not do in most fishing situations. Although a knot may seem insignificant and hardly noticeable to the observer, it can be, and quite often is, the crucial factor between success and failure. Most knots reduce line strength. By moistening all monofilament knots before bringing them tight, you will get a stronger knot.

**Note:** The first five knots are the required knots, while the others are still worth knowing.

**Arbor Knot.** The arbor knot attaches the fishing line to the reel arbor or spool hub. The line must be secured to the reel so that it does not slip off. This knot is tied by first passing the fishing line around the reel spool or arbor, then tying an overhand knot (half hitch) around the main line. Then tie a second overhand knot on the end of the lead end. Next, tighten the overhand, closing tighter as it slides down on the spool. Pull the main line tight, and the second overhand will serve as a stopper knot by sliding it tight snug to the first overhand. Trim the excess.

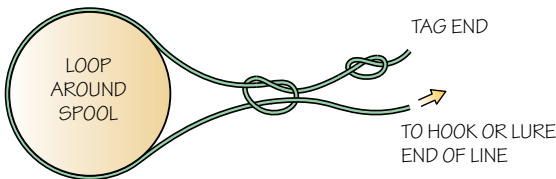

**Improved Clinch Knot.** This is the universal knot for tying monofilament to a hook or for tying hooks and swivels—any object having an eye—to the line. Because monofilament is slippery, it needs a knot that will jam against itself and hold tight, yet not cut itself. Thread the line through the hook eye and pull out about five or more inches of monofilament. Wrap the tag end around the standing line five turns and put that line back through the space between the hook eye and the first line wrap. Then bring the line back through the big loop just formed and pull it through enough so it will stay put. Wet the knot, hold on to the hook, and pull on the longer line as you keep the short line end taut. Push the knot toward the hook eye and snug it tight. Trim any excess.



**Palomar Knot.** This basic knot serves the same purpose as the improved clinch knot. Double the line to make a 3- to 4-inch loop, then pass the end of the loop through the hook eye. Hold the standing part between thumb and forefinger and tie a loose overhand knot in the double line with the other hand. Then pass the hook through the loop and pull on the doubled line to tighten the knot, guiding the loop over the top of the eyelet. Clip the tag end.

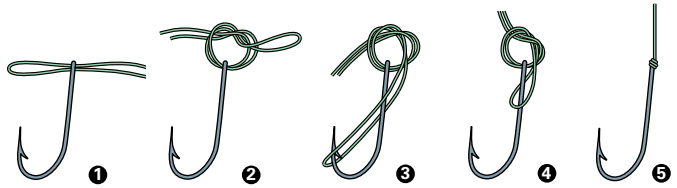

**Uni Knot.** This knot is easy to tie and very popular for placing a hook or lure on the monofilament line. First, run the monofilament line through the eye of the hook and bring it parallel with the standing line. Now make a loop by bringing it back toward the hook eye, and wrap the tag end upward inside the loop. Then wrap it around both the lines five or six times. Pull the knot tightly, then moisten it and slide it down to the eye of the hook or swivel. Make sure it is tight, and trim any excess from the tag end.



**Uni to Uni Knot.** This knot is used to attach or reattach two sections of line. Start by overlapping the tag end of your line to be attached to the standing line eight to 10 inches. Now take your standing line end, tie a uni knot around the tag line four or five times, and pull the knot tight. Start the second knot with the tag end forming the uni around the standing line with four or five wraps. Pull the second uni snug, and draw the two knots together tightly. Tighten the tags firmly and trim the excess tags, making a smooth transition.

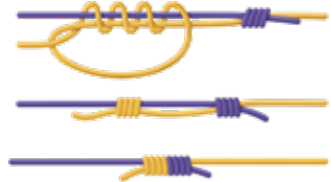

## Other Knots Worth Knowing

**Blood Knot.** This knot is usually used to join two sections of line or leader, even if they are of slightly different diameters. Lap the ends of the lines or leaders several inches. Then twist one around the other, making at least five turns. Place the end between the strands and hold them together between thumb and forefinger. Wind the same number of turns (five) in the opposite direction, using the end of the other line. Pass that end through the same space of the first line, but in the opposite

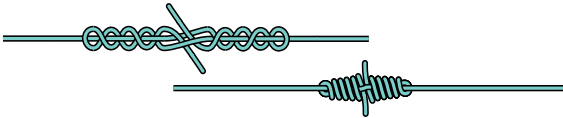

direction. Then pull on the two ends to draw the turns closer together. When they have closed up snugly, pull tight on the ends to make the knot as small as possible. Clip the ends.

**Double Surgeon's Loop.** A double surgeon's loop is an easy way to form a loop in the end of a line or leader. Double the end of the line and make a single overhand knot. Then pass the loop around and through the overhand knot again. Hold the loop in one hand and the standing part and tag end in the other hand. Moisten the knot with water and pull to tighten. Clip off the tag end.

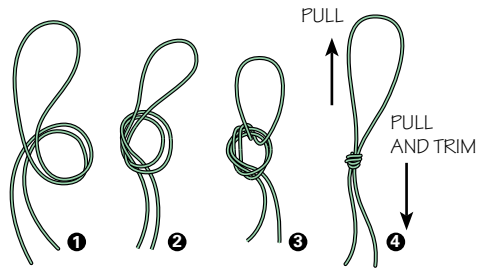

**Loop Knot.** This is used to tie on lures that require freedom of movement. Tie a loose overhand loop and pass it through the eye of the lure. Pass the running line through the open overhand loop and create an overhand loop around the standing line. The front knot is pulled tight, then the back

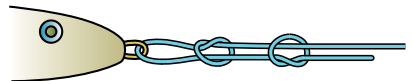

A chain is only as strong as its weakest link, and a fishing line is only as strong as its knots. It would be sad to lose a nice fish because of a poorly tied knot. Always use the proper knot for each occasion, and practice these knots often. Test your knot after tying. You do not want it to fail when hooking the fish of a lifetime.

**Loop-to-Loop Knot.** This knot combines two leaders, each with a double surgeon's loop. The leaders can be changed easily with this connection.

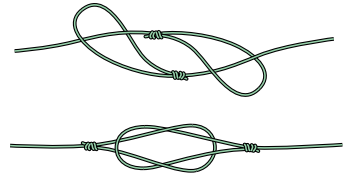

**Surgeon's Knot.** This is a line-to-line joining knot. Start by laying the two lines to be joined with tag ends in opposite directions, overlapping by six-plus inches. Now take the overlapping lines and form a double overhand knot, passing the tag end and the entire shorter line through the loop twice. Finish by moistening the knot and pulling both ends tight.

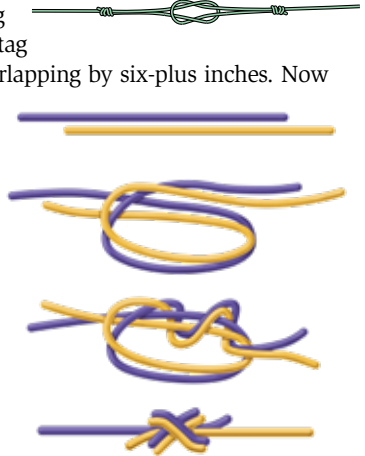

### Required Knots for the Fishing Merit Badge

Line to Reel	Joining Knots	Terminal Tackle Knots		
		Line to hook or lure		
Arbor Knot	Uni to Uni Knot	Uni Knot	Improved Clinch Knot	Palomar Knot

### Other Fishing Knots Worth Knowing

Loop Knots	Line to Line			Terminal Knots
	Joining Knots			
Double Surgeon's Loop	Blood Knot	Surgeon's Knot	Loop-to-Loop	Loop Knot

## Hooks

**Fishhooks** are made of steel wire, bent by a machine to a desired shape, hardened by heat, and given a rust-resistant finish.

Hooks come in a wide range of sizes. Different hooks are designed for bait-fishing, lures, and flies. The hook you choose should be suitable for the fish you wish to catch. It can be confusing trying to figure out hook sizes, but one simple way is to start with size 1. The larger the number, the smaller the hook. Thus, a size 2 is smaller than 1, and a size 4 is smaller than a size 2. Size 28 hooks are so small they are hard to see!



Going the other way, the addition of /0 means the bigger the number, the bigger the hook. A 1/0 is bigger than 1, a 2/0 is bigger than 1/0, and so on. A 12/0 hook is very large and is used to catch big fish such as tuna and shark.

Hooks also come in a variety of shapes. Straight-eye hooks are used most often with snaps and leaders. Turned-down-eye hooks are used for bait fishing and flies. Some hooks have sliced shanks to better grip live bait. Circle hooks are becoming increasingly popular because they often are self-setting, catching the fish on the outer jaw where they are less likely to be injured.

Barbless hooks play a role in safety both for the fish and for anglers (who might accidentally get hooked). These special hooks are made without barbs. As more and more anglers release their catch, barbless hooks make hook removal faster and safer. Some fisheries even require barbless hooks. Many anglers believe a barbless hook will lose fish, where a standard barbed hook helps ensure a catch. With good line control that is not a problem.

Anglers who practice catch and release often use barbless hooks or pinch the barbs down, allowing for the easier release of fish. Should one get a stray hook lodged in them, barbless hooks can slide out rather easily.

Jig hooks are made so that the wire will not twist inside the leadhead.

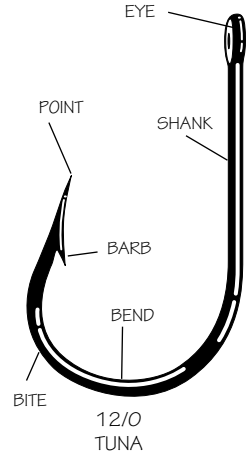

---

Hooks must be kept sharp to be effective. And care must be taken that they get stuck only in fish, not in people.

---

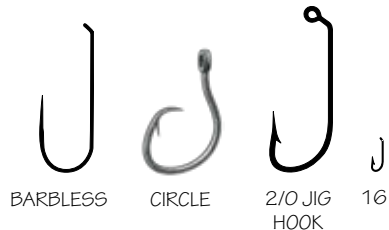

## Sinkers

Many types of **sinkers**, each designed for specific types of fishing, are useful in getting the bait down to the fish. Some of the more common sinkers include the following:

- Trolling sinkers, which move through the water effectively
- Split-shot sinkers, which come in a variety of sizes and are designed to be pinched on the line or leader
- Worm sinkers, which are effective in weed beds where plastic worms might snag or tear
- Dipsey and pyramid sinkers, which usually are used when a lot of weight is needed on the line
- Barrel sinkers—named for their shape—have a hole so the line can run free



Other types of sinkers include:

- Clinch-on sinker, which has two wings that can be bent over the line or leader and squeezed tight
- Saltwater sinker, popular with anglers who need a weight that will grip the bottom in tide and surf
- Heavy bank sinker, used for deep-sea fishing
- Sliding sinker, which has a hole in it so that the line can slide through when a fish strikes, and which can slide over the bottom without snagging
- Keel sinker, which is used for trolling, because the keel keeps the weight from twisting the line

Despite the best intentions, anglers sometimes lose sinkers. Sinkers are often made of lead, and lead is toxic to wildlife. Scientists have discovered that lead sinkers have been responsible for the deaths of a number of loons and other water birds that accidentally ingested them. Wildlife experts are urging anglers to consider sinkers made of environmentally friendly materials such as rock, ceramics, iron, steel, and bismuth. Some states have instituted a lead-sinker exchange program in which anglers may exchange their lead sinkers for lead-free alternatives such as tungsten or tin.

## Swivels

Many lures and baits have a tendency to twist the line, causing it to kink and snarl. **Swivels** are designed to allow the baits to revolve, helping to eliminate the twisting. Many swivels are built with snaps, which allow a hook, lure, or leader to be clipped on without using a knot.

Using a three-way swivel allows a no-twist connection to the line, a no-twist connection with a leader to the hook or lure, and another no-twist connection to a separate leader and a sinker. Some species of saltwater fish are extremely powerful, requiring special steel swivel-snap combinations.

### Swivels



SNAP  
AND  
BARREL



BARREL



THREE-WAY

## Bobbers/Strike Indicators

Years ago, many anglers made their own bobbers and floats from corks, balsa wood, or porcupine quills.

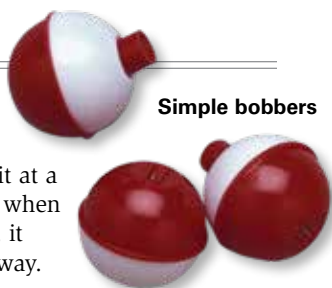

Simple bobbers

Strike indicators not only hold the bait at a fixed depth, they let the angler know when a fish bites. As the fish takes the bait, it causes the strike indicator to dip or sway. Simple bobbers have been around for years and are a type of **float**. They are inexpensive and popular for the young or casual angler. The problem is they are not nearly as sensitive as a pencil type of float. If you wish to more easily detect a bite, pencil floats will deliver a higher catch rate. All floats are attached to the fishing line and are adjustable to allow the bait to be adjusted to a favorable depth.

**Bobber.** The simplest kind of bobber has a wire loop on the top and bottom that operates on a spring so that the line or leader can be clipped on and anchored in place. The bobber is effective to hold the line depth and will detect a strong bite as it dips in response to that strike. You can miss a light nibble, though, as fish strip a worm from your hook without detection. Bobbers are made of plastic and are inexpensive.

**Weighted Bobber.** Weighted plastic bobbers make it easier to cast a light bait or a fly far on regular spinning tackle.

**Pencil Float.** These are long, thin, and light and are effective for fish that bite lightly. With a pencil bobber float, a fish will feel no drag or resistance when it pulls on the bait. The line is held against the bobber by an adjustable rubber sleeve band.

**Slip Bobber Float.** The slip bobber float has a hollow stem through which the line passes. A sliding knot is tied above the bobber float on the line, and the knot will not go through the tiny hole in the stem. Any depth can be set. When the bait is reeled in, the bobber float will slide down to the hook or sinker, which makes it easy to cast.



Weighted bobber float



Slip bobber float



Pencil bobber float

## Live Freshwater Bait

Natural foods are easy to fish, require a minimum of tackle, and are highly effective. Anglers may seek out their own bait or purchase it in specialized bait shops.

Be aware that releasing live bait and bait water can introduce undesirable fish, parasites, or diseases to native fish. To ensure that you do not accidentally make an unwanted biological introduction, try to obtain live baits that are native to the waters you intend to fish. At the end of the fishing day, do not release live bait (regardless of origin) into the water. Dispose of unused live bait and any water in the bait bucket on land well away from any water.

Before you make your live-bait choice, be sure to check the local fishing regulations regarding the use of live bait. Some classes of live bait may be permitted in your area only during certain times of the year or not at all.

**Worms.** Red worms, garden worms, and night crawlers all are good baits. A small hook (size 8 to 12) embedded in the head of a worm works well for many species. For bluegill, use small worms or pieces of a worm to hide the hook.



**Minnows.** Anglers use dozens of minnow varieties as bait. One common method is to hook the minnow through both lips, from the bottom up. Another is to put the hook through the body near the tail or just behind the dorsal fin.

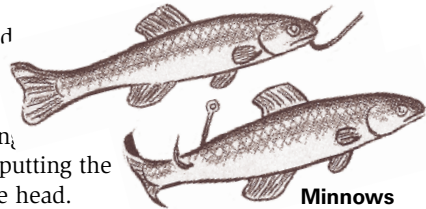

**Crickets.** Crickets are a great bait when fishing for bluegill and sunfish. If the fishing are not biting on worms, try a live cricket. Hook the cricket by putting the hook under the collar (or thorax) right behind the head.

**Crayfish.** As crayfish grow, they shed their hard outer coat several times in the summer. When in the "soft" state they make an excellent gamefish bait.



**Leeches.** The ribbon leech is an excellent and hardy bait. Most fish will reject bloodsucking leeches.

**Hellgrammites.** These larvae of the dobsonfly are found under rocks in riffles. They are excellent bait but must be kept off the bottom or they will snag the hook.

## Live Saltwater Bait

All popular species of saltwater fish can be taken on live bait. Anglers who live near the coast often catch their own. Others purchase theirs in bait shops. It takes considerable knowledge of each fish species to know which bait to use and how.

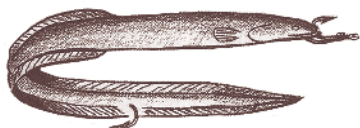

**Eels.** These are a common bait along the East Coast, particularly for striped bass and bluefish. Anglers often place eels on a double-hook rig, usually with a weighted hook in the head.



**Crabs.** Several species are used as bait, the fiddler crab being the most common. The larger claw is pulled off and the hook embedded in the crab at that point.

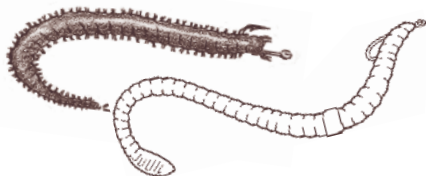

**Sandworms.** Along with bloodworms, sandworms are a popular bait. For large fish, the whole worm is hooked on. For smaller fish, the worm may be cut up and just a piece used.



**Shrimp.** Used whole or with just the tails on the hook, shrimp are excellent for a wide variety of fish. A piece of shrimp on a jig is highly effective.



**Squid.** Cut into strips, squid will take many species of saltwater fish. Other cut bait such as mullet or menhaden are used for weakfish, bluefish, channel bass, and striped bass.

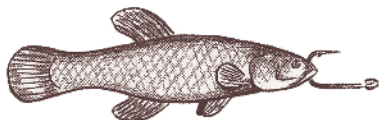

**Baitfish.** There are many varieties of baitfish, which can be caught live in a net when fishing or at a bait shop. Baitfish are fished live, hooked through the nose. Before going fishing, research the type of baitfish eaten by fish in your area, or by the species of fish you will be fishing for.



**Clams.** These come in many sizes. Small clam meats are used whole; large ones may be cut up. Clam meats are obtained by pushing a knife between the shells and severing the muscles.

## Artificial Lures

While some anglers prefer the natural attraction provided by live bait, others favor artificial lures that can be bought in sporting goods stores or made meticulously by hand.

**Jigs.** Hooks with lead weights molded into the head—called leadheads or jigs—are the basis for a whole range of popular artificial lures. The advantage is in having a single-hook lure that is compact but that can carry enough weight to be easily cast by a bait rod or spin rod. Jigs also are adaptable to a variety of styles that allow them to imitate food that fish recognize.



There are several styles of plastic-bodied grubs impaled on a jig hook. A bucktail hair tied to create a weighted streamer fly, a weedless bucktail designed for fishing in brush, and a twister-type plastic body that has a wiggling tail in the water. Also included is a Canadian minnow-type jig made with a soft chenille body, feather hackle front and back, and a feather tail.

### Tips for Using a Jig

- Jigs are meant for slow, patient fishing. Retrieve them very slowly in cold weather or when ice fishing.
- Retrieve jigs with action—jerks or pulls imparting a swimming motion.
- When a fish strikes a jig, it may be detected as only a twitch in the line. Be aware, and set the hook immediately.
- Fish with the lightest jig that allows you to feel when the jig is on the bottom.
- Be sure to keep jig hooks sharp so they are not easily dislodged.

Plastic worms are fished slowly, on or near the bottom. With the Texas rig or weedless rig, the fish is allowed to mouth the bait before the hook is set.



**Plastic Baits.** These soft, pliable lures in varying styles and shapes can be made to swim, wiggle, and dance underwater with an action the fish cannot resist. They are used plain on a bare hook, impaled on a jig, or effectively utilized with several popular rigs. Bass are particularly attracted to these artificial worms, which the industry provides in different styles, shapes, and colors. In addition, scented soft baits are available in numerous styles.

**Spoons.** When anglers noticed that minnows and certain other aquatic creatures glistened in the sunlight, the idea of making lures out of shiny metal was born. Spoons are made by cutting pieces of metal to shape, hammering them out so that they wobble in the water, and polishing them to a high shine. Various colors of enamel are added to some; others are given gold or silver finishes. They are called spoons because most of them are shaped like the lower part of a teaspoon.

**Spinners.** A spinner is made by hammering a piece of metal very thin, drilling a hole in one end, and mounting it on a strip of wire. The metal blade spins around the wire shaft, glinting like a live minnow swimming in the sunlight. Spinners may be rigged with hair flies, feather streamers, or live bait. Sometimes they are used alone with the blade and hook. Most spinners work best if retrieved slowly, just fast enough for the blade to revolve without being a blur. Spinners are sometimes rigged with jigs for deep fishing. These might have snaps that can be clipped to the eye of the jig.



When trolling, anglers use a cowbell rig, a multi-bladed variation of the single spinner.



**Plugs or Crankbaits Plugs.** The first plugs—minnowlike replicas—were carved out of wood. Some still are, but most are made of plastic by lure manufacturers. Floating-diving plugs rest on the surface until reeled in. They are designed to wiggle in the water like a minnow or crayfish.

Some crankbaits are made to run deep. These may be either all metal or weighted with metal and plastic. Some have a long bill in the front that causes them to head for the bottom when retrieved. They also are effective lures when trolled behind a boat.

Some surface baits are made to imitate a frog hopping, a mouse swimming—or, perhaps like a popper, an injured minnow or insect that is flopping around in distress. Bass, pike, and muskellunge are species most often caught on these gurgling, popping, and sputtering lures.

**Floating-diving plug**



**Deep-running plug**



**Surface plug**

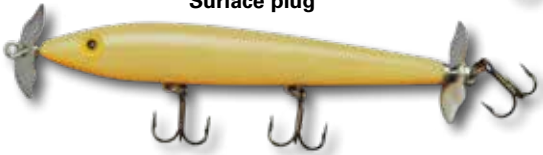

Most plugs have several treble hooks, and anglers must take care not to stick themselves or their fishing companions on the barbs. It is recommended for safety that treble hooks be replaced by inline single hooks.

## Flashing Minnows

Fish often pursue schools of minnows up to the surface, causing the minnows to skip from the water in a desperate attempt to escape. These surface eruptions, called boils, show that there are gamefish below on the feed. Casting minnow-like lures into these spots is often a surefire way of catching the gamefish that are chasing the schools of minnows.

**Flies.** Flies are tied to represent insects, primarily but also crabs, shrimp, and tiny minnows—the preferred food of trout, salmon, and many other gamefish such as bass, panfish, carp, and pike. The fish are deceived into taking the imitation of their food. Some flies can also simulate hatching insects. Flies are made of hair, feathers, wool, chenille, and many other natural and artificial materials, all held together on the hook with thread and glue.

**Dry flies** are tied on light wire hooks and are constructed so that they will float like a newly hatched land-based insect that has fallen into the water. Casting a dry fly so that it lands lightly and floats naturally requires skill.

**Wet flies** are tied so that they sink and are fished beneath the surface. They are meant to imitate aquatic insects as they emerge to hatch as well as many organisms that swim. Trout and other species feed on these in great numbers.

**Nymphs** simulate aquatic insect larvae that live in the silt and gravel in stream and lake bottoms. Nymph flies are tied to represent these different types of larvae. Nymphs rise to the surface to hatch as mature insects.

Longer hooks, wisps of hair, and soft feathers make the long, slim **streamer flies** appear like shiners, chubs, darters, and other minnows. Sometimes they can be sunk with a split shot to get into the deep holes where big trout lie. Most streamers, especially in salt water, are fished rapidly in swift jerks to imitate frightened minnows racing for freedom.

Both largemouth bass and smallmouth bass are ever on the alert for big bugs, frogs, mice, or anything else edible that might fall into the water. **Bass bugs** or **poppers** are tied with cork or hair bodies so that they will float easily. Some have concave heads that make a noisy pop when jerked on the surface with a fly rod.

Sick or injured minnows often struggle on the surface. Bass spot these **cork minnows** as an easy meal and are quick to gulp them down.



---

Tied with hollow deer hair, the **hair mouse** lure looks like a little mouse that stumbled and fell into the water—all a bass or a big brown trout needs for a quick lunch.

Usually tied with hairy legs and painted with green spots, these high-floating **cork-bodied frogs** appear to the fish just like the real thing.

Cork bugs can be made more lifelike by adding strands of **rubber legs** that stick out of the sides and wiggle to mimic swimming. Small cork-bodied lures, called **panfish bugs**, are sometimes the best baits for bluegills, rock bass, and crappies, particularly in the spring when these fish are in the shallows.



## Rigs

When bait is used with any combination of bobbers, line, sinkers, and hooks, an angler's **rig** is created. The rig usually is connected to or fashioned from the end of the fishing line.

### Freshwater Live Bait Rigs

There are many combinations of freshwater rigs, and each one has a special function.



**Slip Sinker.** Designed to get the bait down to the bottom while also allowing the fish to run free without any drag on the line, the slip sinker has a hole through which the line can run freely. A swivel and snap below the sinker keep the sinker from sliding down to the hook.

**Jig-and-Bait.** This is an old standby with most freshwater anglers. The leadheaded jig gets the bait down to the fish where it can be drifted or retrieved in short jerks. Minnows, worms, leeches—all live bait—work well with this method. When a fish strikes, it must be allowed to run with the bait before the hook is set.





**Slip Float Rig.** With the slip float rig, the hollow stem on the slip float allows the line to slide through to a preset depth. However, when the bait is reeled in, the float slides down to the sinker. Thus, the angler can cast the bait some distance away, yet the bait and sinker will drop to the proper depth. A wisp of heavier Dacron tied to the line makes a knot that stops at the float tip.

**Floating Jig Head.** Instead of a leadhead, the floating jig head is made of foam or hollow plastic. This rig, with live bait, is used with a slip sinker and is designed to get down to the bottom but will keep the bait and hook 18 to 24 inches off the rocks. It is an effective and relatively snap-free method of fishing all varieties of live bait.

### Saltwater Bait Rigs

Surf anglers generally use two basic rigs when fishing with natural baits. The first, the standard surf rig, uses a three-way swivel tied a few inches above a pyramid sinker. The hook and leader are tied to one eye on the three-way swivel, and the line is attached to the remaining eye.

The other rig is known as the fish-finder rig. The fish-finder has a ring on one end and a snap on the other. A large-sized snap swivel may be used as a substitute. A barrel swivel is inserted between the leader and the line to act as a stop.

Both rigs can be used with different leaders and various sizes and types of hooks, depending on the fish you are after. Leaders made from monofilament, fluorocarbon, wire, or stainless-steel wire measuring about 18 inches long are recommended. Either rig can be used for striped bass, redfish, bluefish, weakfish, sharks and other surf-feeding fish.



SURF RIG

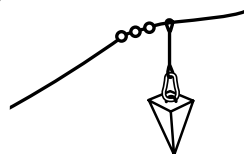

FISH-FINDER RIG

You can attach a cork to a surf rig or a fish-finder rig leader to float the bait off the bottom and help keep it away from crabs and bottom snags.

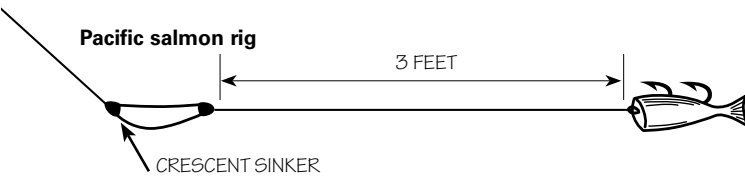

**Pacific Salmon Rig.** This is an ideal rig for slow trolling or drifting when fishing for king and coho salmon. A plug-cut or a whole herring is attached to a two-hook rig on a 3-foot leader. The leader is attached to the eye of a crescent sinker weighing from 2 to 6 ounces, depending on the current and the depth you want to fish. Let the rig go down to the bottom, and then reel back slowly. When you get your first strike, mark your line so that you can let the rig down to the same depth again.

**Summer Flounder Rig.** To rig for fluke, attach 2 or 3 feet of leader to one eye of a three-way swivel. Attach a sinker to another eye with only an inch or two of leader line. Then, attach a long-shanked hook to the end of the leader. Use a strip of squid or clam for bait. To further enhance the rig and draw the attention of more fish, add a spinner blade or two to the leader.

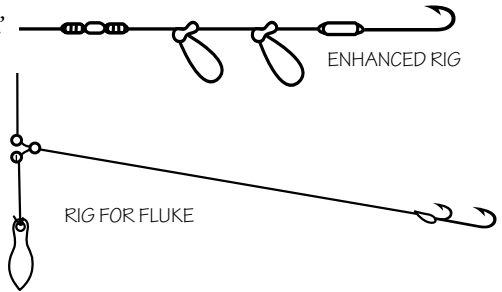

**Winter Flounder Rig.** This two-hooked rig uses a wire spreader to keep the two hooks apart so that they can lie together on the bottom where the flounder will be feeding. The sinker is attached to a snap in the middle. The single-hooked rig has its hook tied a few inches above the sinker. Both rigs use a long-shanked hook tipped with a small piece of clam or sea worm.

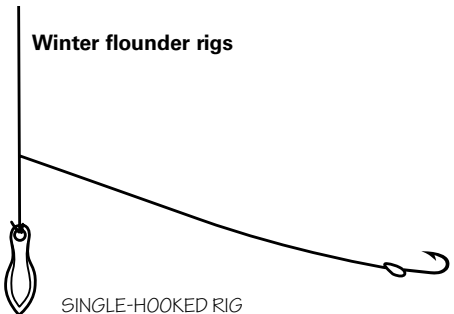
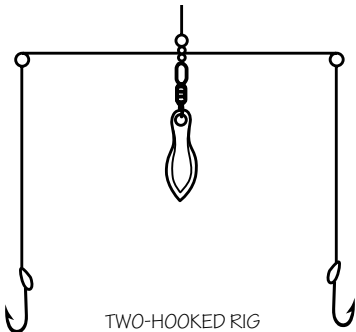

---

Inexpensive tackle carriers can be adapted from plastic boxes that are sold in hardware stores to hold bolts, nuts, and other small items.

---

# Fishing Gear and Craft

Before you head out to fish a lake or stream, you'll need to pack a **tackle box**, a landing net, and other necessary gear. To ensure an enjoyable day of fishing, be sure you dress for the weather conditions.

## Tackle Boxes

Carrying cases for lines, leaders, hooks, lures, reels, and other pieces of equipment come in a wide range of sizes. New, rugged, noncorrosive plastic tackle boxes have largely replaced the old metal boxes used years ago. All tackle boxes are designed to keep the items separated so that they do not become tangled. Some anglers keep all their tackle in a large box, using smaller boxes to carry whatever they will need for one day. Some have separate boxes for spinning, spin-casting, bait-casting, saltwater, and/or fly-fishing equipment. A well-ordered tackle box makes fishing easier and is the mark of an experienced angler.

Many fly fishers prefer plastic or aluminum boxes to hold individual flies. Usually all the flies needed for one trip can easily be carried in a small box that fits in a jacket pocket.



Over the years many items worth a lot of money may accumulate in a tackle box, some of them difficult to replace. Smart anglers are careful not to drop their tackle box into the lake or stream nor to leave it on the shore unattended and vulnerable to theft. Rinse lures and tackle in clean freshwater and allow them to thoroughly dry before putting them away. This will help ensure long-lasting and dependable tackle.

## Tackle Box Items

Among the usual lures, line, and other necessities, consider storing a few of the following items with your tackle.

- A pair of gloves
- Sunglasses
- A disposable or waterproof camera
- A small first-aid kit
- Hand towels or wet wipes
- Insect repellent
- Sunscreen
- A compass
- A boot repair kit
- Duct tape



## Landing Nets

Landing nets come in a variety of sizes, from small, light, trout nets that hang from a cord around the body to huge boat nets. Newer nets are made of soft rubber or silicone for the safety of the fish. The older style netting made of heavy, knotted thread tends to remove the fish's protective slime coating.

The type of fishing an angler will be doing determines the type of net to be used. You can land some fish by hand, but using a landing net helps ensure that the fish will not slip and get loose. If the fish is to be released unharmed, it is better to reach down with the fingers or with pliers and slip the (hopefully barbless) hook loose while the fish is in the water.

## Stringers

In cool weather when the water is cold, some species of fish may be kept alive on a stringer until the day is over. **Stringers** with individual snaps are best, keeping the fish separated and allowing them more breathing room.

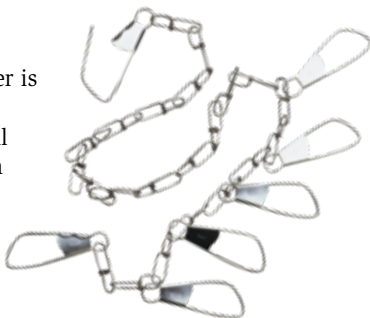

## Accessories

**Fillet Knife.** A good, sharp knife with a long, thin, flexible blade is best for cleaning fish. It should be kept secure in a sheath when not being used.

**Sharpener.** A sharpening system capable of honing a razor's edge should be available at home. For fishing trips, a small steel or diamond-edge sharpener will touch up the blade when work needs to be done. Such a sharpener also can be used to touch up hook points that get dull.

**Line Clipper.** Anglers always should use some type of cutter or knife to cut monofilament line, never the teeth. A fingernail clipper on an elastic cord is a handy item.

**Long-Nosed Pliers.** Use these pliers for taking hooks out of fish and for straightening bent hooks. Pliers should be equipped with a wire cutter.

**Reel Oil.** A can of oil and a small tube of gear grease will keep reels running smoothly and make them last years longer.



## Clothing

Since fishing is an outdoor pastime, wear clothing suitable for the season that will protect you from the elements.



**Rain Gear.** Anglers discover quickly that rain often accompanies some of the best fishing. The best outfits are matching rain parkas and pants in earth tones, made of waterproof and windproof fabric. Lightweight rain gear can be rolled into a small package and stowed in the pocket of a jacket or pack. Ponchos will do a good job of shedding rain, but they provide poor coverage on windy days and make casting difficult.



**Fishing Vest.** This handy many-pocket garment is useful for carrying hooks, leaders, flies, lures, bait, and other items. The fishing vest helps keep an angler's hands free. While it is not a necessity, it is convenient for the angler who can afford one. When shopping for a fishing vest, think about the weather conditions you will encounter. Be aware of the bulk your filled pockets may create. You might want to consider a vest that comes with a personal flotation device built in—it will inflate if you pull a cord.



**Footgear.** Sneakers or leather boots with good traction are suitable footwear for fishing from a boat, but the wading angler needs to pay careful attention to the feet. In cold weather, or in icy trout streams or surf, hip boots—or better yet, chest-high waders—help keep the legs dry. In warm streams during summer, it may be tempting to wade barefoot, but wading with bare feet invites injuries from broken glass, rusty nails, lost hooks, or even a spiny sea urchin. To avoid foot and leg injuries, wear a pair of old shoes and old jeans.

Some states prohibit felt-bottom wading boots because they might harbor and transfer unwanted organisms between water bodies. Be aware of invasive species in your area, and strive to follow all regulations.

## Fishing Craft

Almost any kind of watercraft can be used for fishing. Some boats lend themselves more readily to angling than others, and some boats are designed specifically for fishing.

During any Scouting activity afloat, your group must abide by Scouting America's Safety Afloat procedures. Remember to always wear a personal flotation device whenever you are afloat. Your Scout leader can review the Safety Afloat guidelines with you.

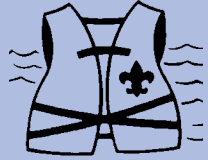

### Bass Boats

These craft are unique to a special kind of angling. The seats are high to make casting easier. They have a large motor to get from one spot to another, and a smaller electric motor that may be used to guide the boat stealthily along the shoreline.

### Canoes and Kayaks

These are at the other end of the watercraft spectrum—light, portable, low in price, and nonmotorized. They are excellent fishing craft, because they make it possible to stalk silently and to maneuver quickly when a trophy fish is hooked. Remember, however, that it may be unsafe to stand and cast in canoes and kayaks unless they are specifically designed to allow you to do so.



---

Canoes and kayaks are handy for getting into those hard-to-reach rivers and lakes that seldom see many anglers.

---

# Cleaning, Filleting, and Cooking Fish

There are as many recipes for cooking a freshly caught fish as there are anglers. Proper cleaning and preparation of a fish before cooking will help ensure success with whatever cooking method you choose.

---

Responsibly dispose of all fish entrails, skeletons, and other remains. If you are on a camping or hiking trip, follow Leave No Trace principles, and treat this waste as you would human waste.

---

## Cleaning Fish

Following these step-by-step instructions for cleaning a fish will make this messy task more manageable.

**Step 1**—Cover the area with brown paper or newspaper. Keep a plastic bag handy for any waste. Make sure you have a sharp flexible-bladed knife.

**Step 2**—Rinse the fish under clean, cool water.

**Step 3**—Remove the scales using a scale remover or knife. (Hold the fish firmly by the head and run the dull edge of your knife from tail to head until the fish feels slick.) Catfish can be skinned and thus won't need to be scaled. To skin the fish, cut down the backside and loosen the skin around the fins. Remove the skin with pliers; pull the skin down from head to tail and cut it off at the tail. Trout do not need to be scaled or skinned.

**Step 4**—Starting at the anal opening near the tail, cut through the belly to the gills.

**Step 5**—Open the belly and remove the entrails and gills from the fish. (Don't burst the stomach.) Scrape out the kidney line (it is reddish-brown) along the underside of the backbone.

**Step 6**—If you want, remove the head by carefully cutting down through the backbone.

**Step 7**—Remove the tail and pull off the dorsal fin (along the top of the fish) with a quick tug.

**Step 8**—Rinse the fish well under cool running water.

## Filleting Fish

Keep in mind that not all fish should be filleted. A trout, for instance, needs only to be cleaned. Removing the meat of some fish from the bones and skin makes it easier to cook and to eat. Here is one way to do it.

**Step 1**—Lay the fish on its side and make a cut just behind the gills down to the backbone, but not through it.

**Step 2**—Start at the cut made in step 1 and run the point of the knife alongside the backbone, down to where it starts to click along the tops of the ribs. Cut alongside the ribs, working back toward the tail until the entire side of the fish is free from the ribs and backbone, but leave it attached to the tail.

**Step 3**—Lay the side flat and hook a forefinger under the skin near the tail. Run the knife into the meat next to the skin and hold the blade against the inside of the skin at an angle of about 45 degrees. Holding the blade steady, gently lift the forefinger holding the skin and pull. The skin will slide out, leaving a boneless, skinless fillet. Repeat on the other side of the fish, and you will have two fillets.

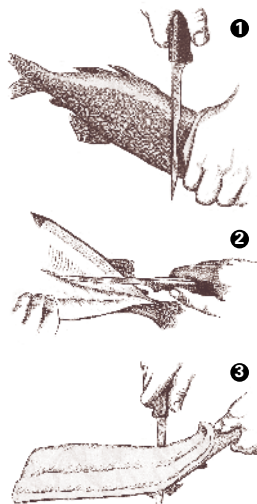

## Cooking Fish

There are dozens of ways to cook fish. The following recipes can be prepared at home or on the trail.

---

Get rid of that fishy smell on your hands by rubbing them with half a lemon and then washing with soap and water.

---



### Baked Fish

Bake your fish at home or in a Dutch oven at camp for a tasty and healthy meal. Heat oven to 450°F. Spray a foil sheet or shallow baking dish with nonstick cooking spray. Prepare the fish, either whole or fillets, with seasoning and arrange in a single layer. Bake the fish in the oven until it is done. Generally, 10 minutes per inch of thickness is all the time needed.

The fillets should flake apart easily for proper readiness.

### Foil-Baked Fish

Place a whole fish or large fillet inside a sheet of heavy aluminum foil. Salt and pepper the fish. Lay two strips of bacon over the top of the fish. Add a slice of lemon, if you wish. Fold the foil lengthwise into a pouch, then fold over the edges, sealing them. Take another sheet of foil and do the same, giving the fish a double layer. Bake in oven or on hot coals for 20 to 30 minutes, depending on the size of the fish.

### Pan Fried Fish

Allow the fillets to drain on a paper towel or similar absorbent material until they are fairly dry. Salt the fillets, then mix a pancake batter or batter made of one egg and 1 cup of self-rising flour. Add a bit of milk to thin the batter. Do not make the batter too thin. You also can bread the fish by





**The trick to turning out tasty fried fish is to have enough hot cooking oil and some type of batter or breading to seal the meat so that the fish cooks quickly without absorbing the oil.**

dipping the fillets in beaten eggs thinned with milk and then rolling them in seasoned cracker crumbs or cornmeal.

Make sure the oil in the frying pan is sizzling hot. Then dip each fillet in the batter and drop it into the oil, being careful not to splatter the oil. When one side of the fillet is brown, flip it and brown the other side. Generally, five minutes per inch of thickness is all the time needed. Remove from the oil and allow the fish to cool a little on a paper towel. Serve hot.

### **Poached Fish**

Almost any fish may be gently cooked in heated liquid such as water, fruit juice, or milk. Poached fish is easy to cook and easy on the digestion. Salt some fresh fish fillets and set them aside. Then melt a little butter in a frying pan. Add a half-inch of milk to the bottom of the pan. Heat the milk until it steams, but do not boil it. Add the salted fish fillets, cover the pan, and let the fish simmer for 10 minutes. Remove and drain the fish. A dash of paprika is a nice finishing touch.

### **Adding Flavor to Your Fish**

When cooking fish, explore different seasonings to find flavors you enjoy. Some enjoy the flavor of fresh lemon or lime and butter with their fish. This works well in a frying pan or when cooking a fish fillet in aluminum foil. Others enjoy a spicier Cajun or blackened seasoning. There are many different fish rubs and seasonings; try other spice combinations. Or top your fish with a mashed fresh fruit blend like fresh berries, diced mango, or a pineapple salsa.



# Protecting Gamefish Resources

The United States has a well-run and healthy recreational fishery. Combined with state fishing license revenue and Sport Fish Restoration taxes paid on fishing tackle and motor boat fuels, more than \$1 billion is invested each year to support a recreational fishing industry that has a combined annual value of more than \$100 billion.

## Obeying Fish and Game Laws

According to the 2016 U.S. Fish and Wildlife Service National Survey, more than 35 million anglers fish each year. With all of these anglers on our nation's waterways, it is necessary for the taking of fish to be regulated so that fish populations do not decline. State conservation departments seek laws that will balance fish production with the harvest. Trained conservation officers patrol the waterways to see that the laws are followed.

**Limits.** Each state puts a limit on the number of gamefish of each species that may be taken by an angler at one time. Limits vary in direct proportion to the availability of the fish. More scarce species have a much lower limit. Muskellunge, for instance, in many states are limited to one a day. Panfish, which are prolific and numerous, have much higher limits or no limits at all. Some areas may have regulations for the catch and release of some species. An ethical angler will adhere to both the letter and the spirit of the law.



**Methods.** As fishing has evolved from being mainly a method for gathering food into a sport, rules of sportsmanship have been incorporated into the regulations. Gamefish must be taken on hook and line and cannot be speared or netted except with a landing net. In some areas, trout may be taken only on artificial flies. Where salmon and steelhead trout migrate up streams to spawn, only single hooks may be used on lures to prevent unscrupulous anglers from trying to snag fish with treble hooks. In many areas, only one lure or bait may be used on one line, and only one line is allowed for each angler.



**Seasons.** To protect fish while spawning, some seasons are set so that gamefish can lay their eggs without interference. For species such as pike and walleye, seasons might open after spawning ends in the spring. For lake trout, brook trout, and other fall-spawning species, the seasons may be closed in late autumn, just before spawning starts. When fish are spawning, they are particularly vulnerable because they savagely strike to protect their eggs.

Failure to know and obey the fish and game laws can lead to an arrest and a stiff fine. True sports enthusiasts never **poach** or consider breaking the rules. Many states have a TIP (Turn In Poachers) hotline telephone number that can be called to report violations. People who break the fish and game laws are stealing from their fellow outdoor enthusiasts and demonstrating a lack of concern for wildlife and the environment.

**Information.** Most marine docks and shops that sell tackle and bait and issue fishing licenses also supply information about local fishing regulations. You might also check with local or district fish and game offices or their websites and social media channels. Be aware that in some cases you may need to obtain a special permit in addition to a basic fishing license.

Most states offer online purchase of fishing licenses and other required permits.



## Fish Resource Management

All states maintain a staff of trained fisheries personnel who conduct research on the resources and determine how recreational fishing license revenue should be spent to get the best results. To determine fish populations, survey nets are set and the fish are tallied as to numbers, age, and growth rates. Where fish numbers are low, either through heavy fishing or for natural reasons, stocking takes place with fry, fingerlings, and yearling fish from state or federal hatcheries.

However, it was discovered that merely adding fish to many lakes and streams did not improve the fishing, thus research has become an important tool. The nation's fishing tackle manufacturers and sportspeople, acting together, got the U.S. Congress to pass a tax on all fishing tackle made and sold in the country. Named for its sponsors in Congress, the Dingell-Johnson Sport Fish Restoration tax money generates hundreds of millions of dollars each year and is apportioned among the states for scientific studies and other related fishing-management practices.

Skilled aquatic biologists use chemistry, electronics, and other aids to determine which species of fish each coastal area, lake, and stream can best support. As the sport of fishing grows, our ability to provide adequate populations will depend more and more on research studies and programs provided by skilled technicians. Perhaps you might like to be a fishery biologist.



## The Future of Sportfishing

All anglers sooner or later discover that it is not enough to enjoy the sport of fishing and the tasty fish dinners that go with it. All anglers find that they have a responsibility to their sport and to the environment in which the fish live. In our modern, complex society, humans have life-and-death control over the waters. How we treat those waters and their resources determines the abundance of gamefish and the future of the sport.

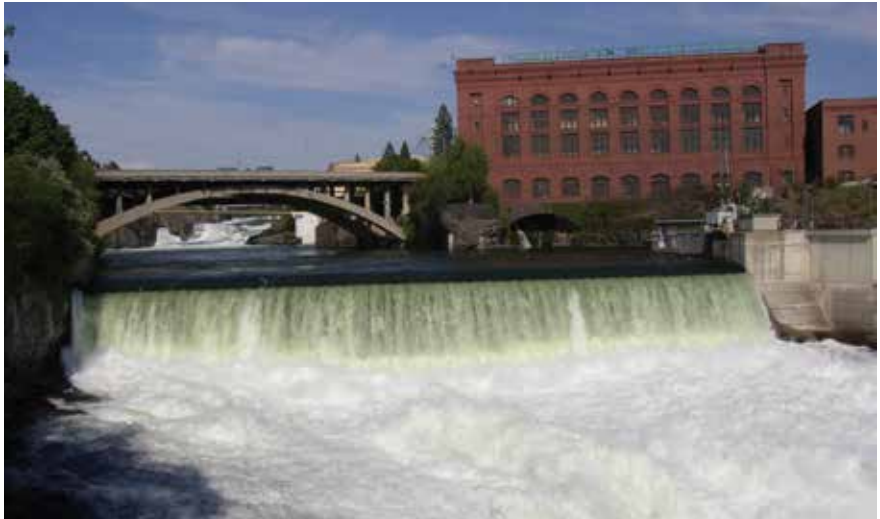

Entire rivers and lakes have been emptied of preferred gamefish because of human-caused pollution or construction of small- and large-scale dams. Likewise, there have been many instances of rivers and lakes reclaimed because anglers and other outdoor enthusiasts banded together and demanded it. Scouts have been active in cleaning up trash from rivers and in assisting state fisheries personnel in the rehabilitation of streams for gamefish species. Because Scouting is based on outdoor experiences, Scouts have always had a high regard for maintaining a quality environment.

As long as we as a nation take care of our water resources, we will always have gamefish for sport and for the table. In a real sense, when we protect the waterways, we also are protecting our own future. Our fate and the fate of fish are inseparable—but only we are able to do something about it.

## Outdoor Code

Scouting America's Outdoor Code helps stimulate awareness of the need for every user of the outdoors to be a responsible patron of outdoor resources.

**As an American, I will do my best to—  
Be Clean in My Outdoor Manners.**

I will treat the outdoors as a heritage. I will take care of it for myself and others. I will keep my trash and garbage out of lakes, streams, fields, woods, and roadways.

**Be Careful With Fire.**

I will prevent wildfire. I will build my fires only when and where they are permitted and appropriate. When I have finished using a fire, I will make sure it is cold out. I will leave a clean fire ring, or remove all evidence of my fire.

**Be Considerate in the Outdoors.**

I will treat public and private property with respect. I will follow the principles of Leave No Trace for all outdoor activities.

**Be Conservation-Minded.**

I will learn how to practice good conservation of soil, waters, forests, minerals, grasslands, wildlife, and energy. I will urge others to do the same.



## Leave No Trace

To ensure a healthy future for ourselves and our environment, we must do more than simply pick up litter. We must learn how to maintain the integrity and character of the outdoors. Leave No Trace is a set of rules, but it is also an awareness and an attitude. Along with the Outdoor Code, the seven Leave No Trace principles offer guidelines to follow at all times. These guidelines apply to fishing as well as hiking, camping, or any other outdoor activity.

- 1. Plan Ahead and Prepare.** Proper planning and preparation for a fishing trip helps ensure a safe and enjoyable experience while minimizing damage to natural and cultural resources. Anglers who plan ahead can avoid unexpected situations and minimize their impact by complying with area game and fish laws, such as size and catch limits, tackle and bait regulations, and seasonal restrictions. Failure to know and obey these laws can lead to an arrest and a fine. Be sure to obtain a fishing license if necessary and any other needed permits or permission before heading out on your fishing adventure.

Obtain information concerning geography, water levels, and weather where you plan to fish so that you are not caught off guard by a storm or rugged terrain. Allow ample time to travel to and from your desired fishing spot, whether on the water or the shore. Take along the proper clothing, equipment, and tackle for the type of fishing you plan to do. It is also helpful to schedule your outing to avoid times of high use.

---

If fishing on the water, be sure to use the appropriate boat launch location.

---

- 2. Travel and Camp on Durable Surfaces.** Whether you fish for a few hours or an entire day, or you plan to camp and fish, it is important to minimize your impact on the land. Damage to land occurs when visitors trample vegetation or communities of organisms beyond recovery. The resulting barren areas develop into undesirable trails, campsites, and fishing spots and cause soil to erode. If fishing from shore in high-use areas, concentrate activity where vegetation is already absent. Minimize resource damage by using existing trails and selecting designated or existing fishing areas.

If camping overnight, always camp at least 200 feet from shorelines. Keep campsites small by arranging tents in close proximity. If you are camping and cooking that day's catch, disperse tents and cooking activities. Move camp daily to avoid creating permanent-looking campsites. Always choose the most durable surfaces available: rock, gravel, sand, compacted soil, dry grasses, or snow.



---

Using a float tube or waders is a good way to minimize your impact. These devices leave little or no lasting impact and allow you better access to the fish.

---

It is especially important to avoid impacting stream banks and lakesides. The area that is immediately adjacent to a stream or river is called the riparian zone. These zones supply food, cover, and water for a diverse number of animals, both in and out of the water. They also serve as migration routes and forest connectors between habitats for a variety of wildlife, especially birds. In addition, riparian zones generally contain more diversity and are more productive in plant growth and animal species than land farther away from the water.

These guidelines apply to most alpine settings and may be different for other areas, such as deserts. Learn the Leave No Trace techniques for your specific activity or destination. Check with land managers to be sure of the proper technique.

**3. Dispose of Waste Properly.** Pack it in; pack it out. This simple yet effective saying motivates outdoor visitors to take their trash home with them. Inspect your fishing spot, boat, or campsite for trash or spilled foods. Accept the challenge of packing out all trash, leftover food or bait, and used or broken fishing line. Use designated fish cleaning areas or check with the local game and fish officials if you will be fishing in a more remote area.

You must properly dispose of any fish entrails or bodily waste in solid waste facilities or by burying them in a cathole. A cathole should be dug 6 to 8 inches deep in humus soil and should be at least 200 feet from water, trails, and campsites.

If cooking in the backcountry, strain food particles from the dishwater and disperse the wastewater at least 200 feet from springs, streams, and lakes. Pack out the strained food particles or bury in a cathole as shown.



---

**Biological Leave  
No Trace:**

Be sure to not dispose of any monofilament or braided fishing line on the ground where birds, mammals, amphibians and reptiles can be entangled.

---



Never leave used fishing line to decompose. Monofilament and braided line can persist in the environment for many years, so make every effort to retrieve broken line and snagged hooks. Dispose of used or broken line responsibly by packing it out with the rest of your trash.

**4. Leave What You Find.** Allow others a sense of discovery, and preserve the past. Leave rocks, plants, animals, archaeological artifacts, and other objects as you find them. Examine but do not touch cultural or historical structures and artifacts that you may stumble across. It may be illegal to remove artifacts.



Never transfer fish from one watershed to another. This can cause the spread of disease and invasive species.

Good fishing spots are found, not made, unless a stream restoration permit is obtained. Avoid altering a site, digging trenches, or building structures. Never hammer nails into trees, hack at trees with hatchets or saws, or damage bark and roots by tying horses to trees for extended periods. Replace surface rocks or twigs that have been cleared from the fishing spot or campsite. On high-impact sites, clean the area and dismantle inappropriate user-built facilities such as log seats or tables and multiple fire rings.



**5. Minimize Campfire Impacts.** If you plan to cook what you catch while on a fishing trip, consider the potential for resource damage. Some people would not think of cooking or camping in the outdoors without a campfire. Yet the naturalness of many areas has been degraded by overuse of fires and increasing demand for firewood. A low-impact alternative is to use a lightweight camp stove. Stoves are fast, eliminate the need for firewood, and make cleanup after meals easier.



---

Practice catch-and-release fishing to help ensure quality fishing for future anglers. The motto, “Limit your kill; don’t kill your limit” should be part of every Leave No Trace experience.

---

If you build a fire, keep it small. Whenever possible, use an existing fire ring and dead and downed wood that can be broken easily by hand. Choose not to have a fire in areas where wood is scarce, and when possible, burn all wood to ash and remove all unburned trash and food from the fire ring. Be certain all wood and campfire debris is cold out.

**6. Respect Wildlife.** Help keep wildlife wild. While fishing, chances are you will encounter other wildlife as well, on the shore or in the water. Avoid disturbing animals by observing them from afar and giving them a wide berth. You are too close if an animal alters its normal activities. Never feed wildlife (except the fish you're trying to catch, of course!).

Store food and garbage securely to avoid attracting wildlife. Be respectful of any catch-and-release areas, and return unharmed to the water any fish that you do not plan to eat, are too small or too big to legally keep, or that exceed the designated **bag limit**.

**7. Be Considerate of Other Visitors.** Thoughtful anglers respect other visitors and protect the quality of their experience. The following are a few tenets of outdoor ethics:

- Travel in small groups. If camping, do so in groups no larger than that prescribed by the land managers.
- Let nature's sounds prevail. Keep the noise down and leave radios, music players, and pets at home. Fish can be spooked by such interruptions. In bear country, however, being a bit talkative on the trail might help prevent a surprise encounter with a bear.
- Select fishing spots and campsites away from other groups to help preserve their solitude and their chances of catching fish.
- Always travel quietly to avoid disturbing other visitors. If fishing from a watercraft, take care not to disturb other anglers' efforts on the water.
- Respect private property and leave gates (open or closed) as found.

The Leave No Trace principles might seem unimportant until you consider the combined effects of millions of outdoor visitors. With the use of designated wilderness areas steadily increasing over the last 50 years, leaving no trace is everyone's responsibility. Use judgment and experience to tailor outdoor activities to the environment. Forest, mountain, seashore, plains, freshwater, and wetland environments all require different minimum-impact practices. Whether outdoors for sport or leisure, you are nature's guest; remember to act accordingly while there.

# Glossary

**auger.** A tool used in ice fishing to bore holes in the ice.

**bag limit.** The number of fish you are legally allowed to keep.

**balance.** The state in which the rod, reel, and line are correctly matched to handle a given-weight lure or bait. Balance allows an angler to deliver the lure or bait with accuracy within any desired distance.

**bass bug.** A type of bass lure made to resemble bugs, frogs, mice, or anything else edible that might fall into the water. It is tied with cork or hair bodies so that they will float easily.

**boil.** An eruption on the water's surface caused by minnows skipping from the water in an attempt to escape fish below on the feed. Boils are a signal of the presence of gamefish.

**creel.** A canvas bag or willow basket made to hold trout that have been gilled and gutted.

**downrigger.** A wire line with heavy lead weights used to get lures deep when trolling for lake trout and salmon.

**fishhook.** A barbed or barbless steel wire hook used to catch fish.

**float.** Keep baits at the correct depth and help detect a bite. Plastic bobbers are popular but only marginally effective. Vertical floats are more effective and will produce more fish.

**fly.** A type of lure made of hair, feathers, wool, chenille, or other materials and held together with thread and glue. A fly is hand-tied to represent insects, baitfish, or other natural food items.

**fly-fishing.** A method of fishing in which a specialized long, flexible rod, a reel, and line are used to cast an artificial fly.

**jig.** A hook with a weight molded into the head. Also called a leadhead.

**landing net.** A net used to land, or bring in, a fish; it helps ensure that the fish will not slip and get loose.

**level fly line.** Inexpensive fly line that may be used for trolling. Generally not recommended for fly casters.

**lure.** Artificial bait used for catching fish.

**plug.** A type of artificial lure that usually resembles a minnow or frog and is made of plastic or wood. It is available in three different styles: floating-diving, deep-running, and surface.

**poach.** To kill or take game or fish illegally.

**rig.** The terminal tackle used for live bait fishing.

**sinker.** A weight used to sink the bait down to the fish. There are various types designed for different types of fishing. Sinks are typically made of lead, but environmentally friendly versions are made of alternative materials such as rock, ceramics, iron, steel, and bismuth.

**spinners.** A type of thin, metal lure that has a hole drilled in one end and is mounted on a strip of wire. It is usually rigged up with hair flies, feather streamers, or live bait.

**spinning.** A form of casting that uses a fixed-spool reel and a spring-operated pickup arm; the line is controlled with the index finger of the casting hand. Long casts can be made effortlessly because there is no movable spool. Also called spin-casting.

**spoon.** A shiny metal lure that imitates minnows by creating wobbling actions in the water; it is shaped like the lower part of a teaspoon.

**stringer.** A string, wire, or chain (often with snaps) used to string fish on the side of a boat and keep them alive in the water.

**swivel.** A device that connects to a hook, lure, or leader and allows the bait to revolve without twisting the line.

**tackle.** A general term for fishing equipment such as the rod, reel, line, lures, etc.

**tackle box.** A carrying case for lines, leaders, hooks, lures, reels, and other pieces of fishing equipment.

**tapered fly leader.** A monofilament line used for fly-fishing, this terminal line is thicker at the fly line and tapered to the fly end. The tapered diameter aids in casting light flies and having them land lightly on the water.

**terminal tackle.** A lure, plug, fly, or baited hook tied at the end of the fishing line.

**weight-forward fly line.** Used for fly-fishing, this highly recommended type of line is heaviest near the terminal end, just before the leader. It gives added weight to cast any fly, including large streamer flies or cork-bodied bass bugs.

**Y bones.** The bones that lie embedded in the meat along a pike's spine; they are shaped like the letter Y.



Lure



Spinners



Stringer



Tackle box

# Fishing Resources

## Scouting Literature

*Scouts BSA Handbook for Boys, Scouts BSA Handbook for Girls, Conservation Handbook, and Fieldbook; Camping, Cooking, Environmental Science, First Aid, Fish and Wildlife Management, Fly-Fishing, Kayaking, Lifesaving, Soil and Water Conservation, and Swimming* merit badge pamphlets

With your parent or guardian's permission, visit Scouting America's official retail site, [scoutshop.org](http://scoutshop.org), for a complete list of merit badge pamphlets and other helpful Scouting materials and supplies.

## Books

Baron, Frank P. *What Fish Don't Want You to Know: An Insider's Guide to Freshwater Fishing*. Ragged Mountain Press, 2004.

Bashline, Sylvia. *The New Cleaning & Cooking Fish: The Complete Guide to Preparing Delicious Freshwater Fish*. Creative Publishing International, 1999.

Circle, Homer. *Bass Wisdom*. Lyons Press, 2000.

Earnhardt, Tom. *Boats for Fishermen*. Lyons Press, 2001.

Kaminsky, Peter, and Greg Schwipps. *Fishing for Dummies*, 2nd ed. John Wiley & Sons Inc., 2011.

Maas, Dave. *Kids Gone Fishin'*. Creative Publishing International, 2001.

National Audubon Society. *National Audubon Society Field Guide to Fishes: North America*, 2nd ed. Knopf, 2002.

Pfeiffer, C. Boyd. *The Complete Book of Rod Building and Tackle Making*. Lyons Press, 2013.

Rosko, Milt. *The Complete Book of Saltwater Fishing*. Burford Books, 2013.

Schultz, Ken. *Ken Schultz's Fishing Encyclopedia: Worldwide Angling Guide*. IDG Books Worldwide, 2000.

Sousa, Robert J. *Learn to Fly Fish in 24 Hours*. Ragged Mountain Press, 2006.

Vick, Noel. *Fishing on Ice*. Human Kinetics, 1999.

Wilson, Geoff. *Geoff Wilson's Complete Book of Fishing Knots and Rigs*. Australian Fishing Network, 2015.

## DVDs

*Casts That Catch Fish*. On the Fly Productions, 2010.

*Joan Wulff's Dynamics of Fly Casting*. Miracle Productions, 2001.

## Scout Life Fishing Site

[fishing.scoutlife.org](http://fishing.scoutlife.org)

## Scouting America Fishing Site

[scouting.org/outdoor-programs/fishing](http://scouting.org/outdoor-programs/fishing)

## Organizations and Websites

### American Sportfishing Association

1001 North Fairfax St., Suite 501  
Alexandria, VA 22314  
Telephone: 703-519-9691  
asafishing.org

### Catskill Fly Fishing Center and Museum

1031 Old Route 17  
Livingston Manor, NY 12758  
Telephone: 845-439-4810  
cffcm.com

### Fly Fishers International

5237 U.S. Highway 89 South, Suite 11  
Livingston, MT 59047  
Telephone: 406-222-9369  
flyfishersinternational.org

### Future Fisherman Foundation

5998 North Pleasant View Road  
Ponca City, OK 74601  
Telephone: 330-993-0014  
futurefisherman.org

### International Game Fish Association

300 Gulf Stream Way  
Dania Beach, FL 33004  
Telephone: 954-927-2628  
igfa.org

### Izaak Walton League of America

707 Conservation Lane  
Gaithersburg, MD 20878  
Telephone: 301-548-0150  
iwla.org

### National Oceanic and Atmospheric Administration Fisheries

1315 East-West Highway  
Silver Spring, MD 20910  
Telephone: 301-427-8029  
fisheries.noaa.gov

### National Park Service

1849 C St., NW  
Washington, DC 20240  
Telephone: 202-208-6843  
nps.gov

### Trout Unlimited

1777 N. Kent St., Suite 100  
Arlington, VA 22209-2404  
Toll-free telephone: 800-834-2419  
tu.org

### U.S. Fish and Wildlife Service

1849 C St., NW  
Washington, DC 20240  
Toll-free telephone: 800-344-9453  
fws.gov

Fly Fishers International, International Game Fish Association, and Trout Unlimited have each signed a memorandum of mutual support with Scouting America that emphasizes an ongoing relationship to promote mutually beneficial programs for recreational fishing.

## Acknowledgments

Scouting America thanks Douglas Precourt; Robert J. Sousa, Ph.D., U.S. Fish and Wildlife Service (retired); and Ben Jelsema, volunteer Scouter, for preparing this revised version of the *Fishing* merit badge pamphlet. Sousa and Jelsema have put in countless hours through the years as coordinators of the fishing programs for the national Scout jamborees. Thanks also to Howard Kern, Master Leave No Trace Trainer, for his valuable assistance.

We are grateful to Howard E. Evans, Ph.D., and Edward Brothers of Ithaca, N.Y., for their expertise and invaluable input, and to Bob Cary, who wrote and illustrated the previous edition of the pamphlet, upon which this edition was based. Several of his illustrations remain in this edition. Thanks also to Trout Unlimited for its support.

Scouting America is grateful to the men and women serving on the National Merit Badge Subcommittee for the improvements made in updating this pamphlet.

**Photo and Illustration Credits**

Brand X Pictures, Bugs and Insects CD—page 14 (*wasp*)

Getty Images—pages 19, 24, 26, 40, 43, 45, 73, and 75

Dan Roberts, courtesy—pages 8, 77 (*filleting*), and 85

Robert Sousa, courtesy—page 29 (*grayling*)

USDA Agricultural Resource Service/Scott Bauer, Bugwood.org, courtesy—page 14 (*attached ticks*)

U.S. Fish and Wildlife Service, courtesy—cover (*fish, bottom left*); pages 23, 29 (*top*), and 83

U.S. Fish and Wildlife Service/Duane Raver—pages 22 (*all*), 31 (*walleye*), 33 (*bluegill*), 34 (*largemouth bass*), 35 (*striped bass*), 36 (*catfish*), 39 (*brook and rainbow trout*), and 43 (*both*)

U.S. Fish and Wildlife Service/Timothy Knepp, courtesy—page 38 (*both*)

Wikipedia.org, courtesy—pages 20 (*bear*), 22 (*lily pads*), 24 (*stream*), 35 (*smallmouth bass*), 33 (*rock bass*), 37 (*pike*), 78 (*fish and rice*), 80, 82, 84, and 89 (*backcountry*)

All other photos and illustrations not mentioned above are the property of or are protected by Scouting America.

Dan Bryant—cover (*tackle box, floating dive plug, spoon, jig*); pages 31 (*bobber*), 51 (*fly*), 58 (*all*), 59, 60 (*all*), 63-66 (*all*), 67 (*three artificial lures*), 71-72 (*all*), 88 (*cathole*), and 93 (*all*)

Ben Jelsema—pages 21 (*trout*), 23, 36 (*fish head*), 39 (*fish in water*), and 79 (*fish frying in pan*)

John McDearmon—illustrations on pages 15, 18, 47, 49, 50, 51, 53 (*arbor knot*), 54 (*Palomar knot*), 55 (*all*), 56 (*loop-to-loop knot*), 57 (*all except circle hook*), 68 (*surf rig, fish-finder rig*), 69 (*all*), and 77 (*all*)

Brian Payne—pages 25 (*surf fisher*), 28, 46, and 74 (*boots*)

Bruce Levitt—page 30

Roger Morgan—page 10

Randy Piland—page 88 (*wastewater*)

Rob Schuster—illustrations on pages 53 (*improved clinch knot*), 54 (*uni knot, uni to uni knot*), 56 (*surgeon's knot*), and 57 (*circle hook*)

Julie Zickefoose—illustrations on pages 19-20 (*both*), 22, and 24

## MERIT BADGE LIBRARY

Though intended as an aid to youth in Scouts BSA and qualified Venturers and Sea Scouts in meeting merit badge requirements, Scouting America's merit badge pamphlets are of general interest and are made available by many schools and public libraries.

Always check [scouting.org](http://scouting.org) for the latest merit badge requirements. If a Scout has already started working on a merit badge when new requirements for that merit badge are introduced, *they may continue to use the same pamphlet to earn the badge and fulfill the requirements therein*. In other words, the Scout need not start over again with the revised requirements.

American Business	Exploration	Plant Science
American Cultures	Family Life	Plumbing
American Heritage	Farm Mechanics	Pottery
American Indian Culture	Fingerprinting	Programming
American Labor	Fire Safety	Public Health
Animal Science	First Aid	Public Speaking
Animation	Fish & Wildlife Management	Pulp & Paper
Archaeology	Fishing	Radio
Archery	Fly-Fishing	Railroading
Architecture	Forestry	Reading
Art	Game Design	Reptile & Amphibian Study
Astronomy	Gardening	Rifle Shooting
Athletics	Genealogy	Robotics
Automotive Maintenance	Geocaching	Rowing
Aviation	Geology	Safety
Backpacking	Golf	Salesmanship
Basketry	Graphic Arts	Scholarship
Bird Study	Health Care Professions	Scouting Heritage
Bugling	Hiking	Scuba Diving
Camping	Home Repairs	Sculpture
Canoeing	Horsemanship	Search & Rescue
Chemistry	Insect Study	Shotgun Shooting
Chess	Inventing	Signs, Signals, Codes
Citizenship in the Community	Journalism	Skating
Citizenship in the Nation	Kayaking	Small-Boat Sailing
Citizenship in Society	Landscape Architecture	Snow Sports
Citizenship in the World	Law	Soil & Water Conservation
Climbing	Leatherwork	Space Exploration
Coin Collecting	Lifesaving	Sports
Collections	Mammal Study	Stamp Collecting
Communication	Metalwork	Surveying
Composite Materials	Mining in Society	Sustainability
Cooking	Model Design and Building	Swimming
Crime Prevention	Motorboating	Textile
Cycling	Moviemaking	Theater
Dentistry	Multisport	Traffic Safety
Digital Technology	Music	Truck Transportation
Disabilities Awareness	Nature	Veterinary Medicine
Dog Care	Nuclear Science	Water Sports
Drafting	Oceanography	Weather
Electricity	Orienteering	Welding
Electronics	Painting	Whitewater
Emergency Preparedness	Personal Fitness	Wilderness Survival
Energy	Personal Management	Wood Carving
Engineering	Pets	Woodwork
Entrepreneurship	Photography	
Environmental Science	Pioneering	

## SCOUTING AMERICA

To place an order,  
call **800-323-0736** or go to  
[scoutshop.org](http://scoutshop.org)



EAGLE SCOUT



THE SUMMIT



SEA BASE

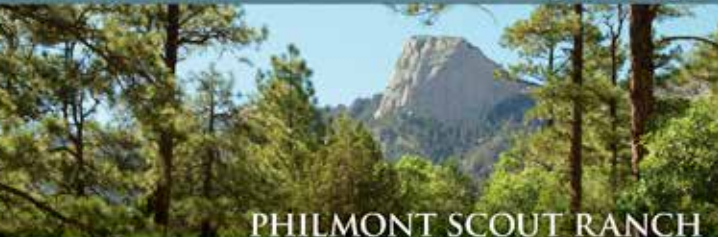

PHILMONT SCOUT RANCH



NORTHERN TIER

Discovery is at the heart of Scouting. We believe every adventure helps us uncover a little more about ourselves. Scouting builds the foundations for courage, resilience, and character, preparing youth for a lifetime of leadership. The path is yours to forge. Who knows what you'll discover?



ON THE ROAD TO HIGH ADVENTURE

SKU 660533



7 30176 80512 2

35899

2026 Printing



Certified Chain of Custody  
At Least 30% Certified Forest Content  
[www.cocprogram.org](http://www.cocprogram.org)  
SFI-CO1268

